

ROASTERS SELECTION

*Including accessories for
baristas and retail channels*

ONLY AT
REPA

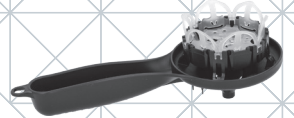
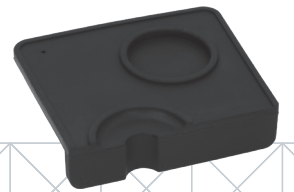

TABLE OF CONTENTS

| | |
|--|----|
| COFFEE TAMPERS | 5 |
| KNOCK BOXES | 10 |
| MILK PITCHERS | 12 |
| DIGITAL SCALES | 13 |
| BREW GROUP SHOWER SCREENS | 15 |
| COFFEE FILTERS | 19 |
| FILTER HOLDER GASKETS | 23 |
| KRUVE SIFTERS | 24 |
| BRUSHES | 26 |
| COMPLEMENTARY ACCESSORIES | 28 |
| MEASURING TOOLS | 32 |
| TOOLS | 33 |
| MOKA POTS | 34 |
| CUPS AND GLASSES | 36 |
| SPOONS FOR COFFEE, CAPPUCCINO, MILK | 38 |
| COFFEE MEASURING SPOONS | 39 |
| EQUIPMENT | 40 |
| FILTERS FOR PERCOLATED COFFEE | 45 |
| VACUUM FOOD CONTAINERS | 46 |
| COFFEE ADAPTERS | 47 |
| DETERGENTS, SPONGES, LIME SCALE REMOVERS, CLOTHS | 48 |



OUR RANGE

Passion and enthusiasm for innovation plus daily commitment to finding the right accessories for preparing every individual cup of coffee lie at the core of the work carried out by our team of coffee specialists.

Thanks to REPA's consolidated experience in the spare parts sector, the REPA Group offers the widest range of parts and accessories necessary for coffee extraction, maintenance and repair work as well as cleaning products for coffee machines.

The REPA Group supports roasters and coffee specialists in ensuring the quality of in-cup coffee and therefore customer satisfaction. That is why we have decided to bring our range of extraction support products together in one dedicated brochure.

REPA Group: every cup counts!



...and much more.

COFFEE TAMPERS



LF Code: 1950013
GEV Code: LF1950013

BARISTA "ROMA" KIT

includes:
1 milk pitcher Europa 0.75 L 1224011
1 milk pitcher Europa 0.50 L 1224010
1 cocoa duster 1094003
1 thermometer 1394554
1 tamper ø 58 mm 1385060
1 tamper holder 1385023
1 latte art pen 1394006



LF Code: 1950014
GEV Code: LF1950014

BARISTA "MILANO" KIT

includes:
1 milk pitcher Europa 0.50 L 1224010
1 milk pitcher Europa 0.35 L 1224015
1 cocoa duster 1094003
1 thermometer 1394554
1 tamper ø 58 mm 1385060
1 tamper holder 1385023
1 latte art pen 1394006



LF Code: 1385070
GEV Code: LF1385070

COFFEE LEVELER ø 58 mm

Equipped with 3 flat blades that distribute the coffee effectively and evenly in the filter, creating a pod of even thickness. Eliminates issues related to the uneven distribution of coffee. Reduces the risk of channelling and micro-channelling
Body ø 62 mm



LF Code: 1385087
GEV Code: LF1385087

COFFEE LEVELER ø 53 mm

Equipped with 3 flat blades that distribute the coffee effectively and evenly in the filter, creating a pod of even thickness. Eliminates issues related to the uneven distribution of coffee. Reduces the risk of channelling and micro-channelling
Body ø 62 mm



LF Code: 1385095
GEV Code: LF1385095

COFFEE LEVELER ø 58.5 mm

Equipped with 3 flat blades that distribute the coffee effectively and evenly in the filter, creating a pod of even thickness. Eliminates issues related to the uneven distribution of coffee. Reduces the risk of channelling and micro-channelling
Body ø 62 mm



LF Code: 1385097
GEV Code: LF1385097

COFFEE LEVELER ø 58 mm

Equipped with 3 flat blades that distribute the coffee effectively and evenly in the filter, creating a pod of even thickness. Eliminates issues related to the uneven distribution of coffee. Reduces the risk of channelling and micro-channelling
Body ø 62 mm



LF Code: 1385098
GEV Code: LF1385098

COFFEE LEVELER ø 58 mm BLACK WHITE

Equipped with 3 flat blades that distribute the coffee effectively and evenly in the filter, creating a pod of even thickness. Eliminates issues related to the uneven distribution of coffee. Reduces the risk of channelling and micro-channelling
Body ø 64 mm

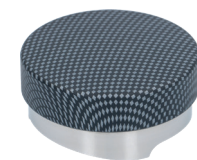

LF Code: 1385111
GEV Code: LF1385111

COFFEE LEVELER ø 58 mm CARBON LOOK

Equipped with three flat blades capable of effectively and evenly distributing the coffee in the filter, creating a pod of homogeneous thickness and eliminating the problems associated with unequal coffee distribution. Reduces the risk of channelling/micro-channelling
Body ø 63 mm



LF Code: 1385127
GEV Code: LF1385127

COFFEE LEVELER ø 58.5 mm

Equipped with three flat blades that effectively and evenly distribute the coffee in the filter, creating a pod of uniform thickness and eliminating the problems associated with uneven coffee distribution. Reduces the risk of channelling/micro-channelling
Body ø 64 mm



LF Code: 3385001
GEV Code: LF3385001

COFFEE LEVELER ø 58.4 mm

Equipped with three flat blades that effectively and evenly distribute the coffee in the filter, creating a pod of uniform thickness and eliminating the problems associated with uneven coffee distribution. Reduces the risk of channelling/micro-channelling
Body ø 64.4 mm



LF Code: 3385002
GEV Code: LF3385002

COFFEE LEVELER ø 58.4 mm

Equipped with three flat blades that effectively and evenly distribute the coffee in the filter, creating a pod of uniform thickness and eliminating the problems associated with uneven coffee distribution. Reduces the risk of channelling/micro-channelling
Body ø 64.4 mm



LF Code: 3385003
GEV Code: LF3385003

COFFEE LEVELER ø 53.4 mm

Equipped with three flat blades that effectively and evenly distribute the coffee in the filter, creating a pod of uniform thickness and eliminating the problems associated with uneven coffee distribution. Reduces the risk of channelling/micro-channelling
Body ø 59.4 mm

COFFEE TAMPERS



LF Code: 3385004
GEV Code: LF3385004

COFFEE LEVELER ø 53.4 mm

Equipped with three flat blades that effectively and evenly distribute the coffee in the filter, creating a pod of uniform thickness and eliminating the problems associated with uneven coffee distribution. Reduces the risk of channelling/ micro-channelling
Body ø 59.4 mm



LF Code: 1385075
GEV Code: LF1385075

BALL ALUMINIUM TAMPER ø 58 mm



LF Code: 1385005
GEV Code: LF1385005

BALL ALUMINIUM TAMPER ø 57 mm



LF Code: 1385004
GEV Code: LF1385004

BALL ALUMINIUM TAMPER ø 53 mm



LF Code: 1385053
GEV Code: LF1385053

ANODIZED ALUMINIUM TAMPER ø 58 mm

flat pressing surface



LF Code: 1385042
GEV Code: LF1385042

POLISHED ALUMINIUM TAMPER ø 58 mm

flat pressing surface



LF Code: 1385041
GEV Code: LF1385041

POLISHED ALUMINIUM TAMPER ø 57 mm

flat pressing surface



LF Code: 1385054
GEV Code: LF1385054

ANODIZED ALUMINIUM TAMPER ø 53 mm

flat pressing surface



LF Code: 1385040
GEV Code: LF1385040

POLISHED ALUMINIUM TAMPER ø 53 mm

flat pressing surface



LF Code: 1385068
GEV Code: LF1385068

TAMPER ESSENTIAL WOOD ø 53 mm

100% Made in Italy, quality and durability. The wooden handle has been designed to ensure maximum performance. The ergonomic shape ensures a comfortable, safe, easy to use handle. The essential line is made with a slighter base without renouncing to the highest quality. Wooden handle, stainless steel base
flat pressing surface



LF Code: 1385069
GEV Code: LF1385069

TAMPER ESSENTIAL WOOD ø 48 mm

100% Made in Italy, quality and durability. The wooden handle has been designed to ensure maximum performance. The ergonomic shape ensures a comfortable, safe, easy to use handle. The essential line is made with a slighter base without renouncing to the highest quality. Wooden handle, stainless steel base
flat pressing surface



LF Code: 1385130
GEV Code: LF1385130

PRECISION TAMPER BROWN ø 58.4 mm

100% made in Italy
Wooden handle, stainless steel base
Flat pressing surface

COFFEE TAMPERS



LF Code: 1385131
GEV Code: LF1385131

PRECISION TAMPER CLEAR ø 58.4 mm

100% made in Italy
Wooden handle, stainless steel
base
Flat pressing surface



LF Code: 1385132
GEV Code: LF1385132

PRECISION TAMPER BLACK ø 58.4 mm

100% made in Italy
Wooden handle, stainless steel
base
Flat pressing surface



LF Code: 1385133
GEV Code: LF1385133

PRECISION TAMPER RED ø 58.4 mm

100% made in Italy
Wooden handle, stainless steel
base
Flat pressing surface



LF Code: 1385134
GEV Code: LF1385134

PRECISION TAMPER BROWN ø 54.4 mm

100% made in Italy
Wooden handle, stainless steel
base
Flat pressing surface



LF Code: 1385136
GEV Code: LF1385136

PRECISION TAMPER BROWN ø 57.4 mm

100% made in Italy
Wooden handle, stainless steel
base
Flat pressing surface



LF Code: 1385600
GEV Code: 802029

DYNAMOMETRIC MANUAL COFFEE TAMPER ø 57mm

aluminium - constant pressure
14 kg



LF Code: 1385601
GEV Code: LF1385601

DYNAMOMETRIC MANUAL TAMPER ø 52 mm

aluminium - constant pressure
14 kg



LF Code: 1385082
GEV Code: LF1385082

DYNAMOMETRIC COFFEE TAMPER ADJUST. 53 mm

handle of aluminium
base of stainless steel
adjustable pressure 15/21 kg



LF Code: 1385083
GEV Code: LF1385083

DYNAMOMETRIC COFFEE TAMPER ADJUST. 54 mm

handle of aluminium
base of stainless steel
adjustable pressure 15/21 kg



LF Code: 1385084
GEV Code: LF1385084

DYNAMOMETRIC COFFEE TAMPER ADJUST. 57 mm

handle of aluminium
base of stainless steel
adjustable pressure 15/21 kg



LF Code: 1385085
GEV Code: LF1385085

DYNAMOMETRIC COFFEE TAMPER ADJUST. 58 mm

handle of aluminium
base of made of stainless steel
adjustable pressure 15/21 kg

COFFEE TAMPERS

HOW TO FIND THE RIGHT TAMPER SIZE FOR YOUR FILTER

Take a caliper to measure the internal diameter of the filter and remove 1 mm from the diameter.

For conical filters: take the internal measurement once the desired compression level is reached.

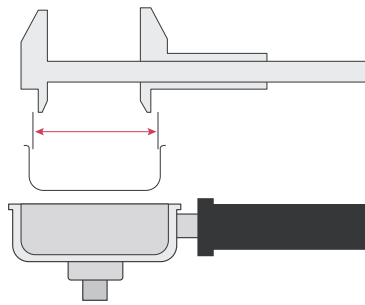

GUIDE ON TAMPERS ADAPTABILITY

| Brand | ø49 | ø53 | ø53.4 | ø54.4 | ø57 | ø57.4 | ø58 | ø58.4 | Remarks |
|-------------------------|-----|-----|-------|-------|-----|-------|-----|-------|---|
| ASCASO | | | | | • | | | | Ascaso Dream, Arc, Basic, Elipse and old 57mm Steel |
| ASCASO | | | | | • | | • | | |
| ASTORIA | | • | | | | | | | Plus 4 you |
| ASTORIA | | | | | | | • | • | |
| ASTRA | | | | | • | | | | |
| AURORA-BRUGNETTI | | | | | | | • | • | |
| BEZZERA | | | | | | | • | • | |
| BFC ROYAL | | | | | | | • | • | |
| BRASILIA | | | | | | | • | • | |
| BUGATTI DIVA | | | | | • | | | | |
| CARIMALI | | | | | | | • | • | |
| CASADIO | | | | | | | • | • | |
| CIMBALI | | | | | • | • | | | |
| CONTI-SACOME | | | | | | | • | • | |
| CREM EXPOBAR | | | | | | | • | • | |
| DALLA CORTE | | | | • | | | | | |
| DE LONGHI | • | | | | | | | | Old models |
| ECM-PROFITECH | | | | | | | • | • | |
| ELEKTRA | | | | | | | • | • | |
| FAEMA FUTURMAT | | | | | | | • | • | |
| FIAMMA | | | | | | | • | • | |
| FRACINO | | | | | | | • | • | |
| FRANCIS FRANCIS | | | | | • | | | | |
| FUTURMAT | | | | | • | | • | | |
| GAGGIA | | | | | | | • | • | |
| GAGGIA SPAIN (VISACREM) | | | | | • | | • | | |
| GRIMAC-FIORENZATO | | | | | | | • | • | |
| GRUPPO IZZO | | • | | | | | | | |

COFFEE TAMPERS

| Brand | ø49 | ø53 | ø53.4 | ø54.4 | ø57 | ø57.4 | ø58 | ø58.4 | Remarks |
|---------------------|-----|-----|-------|-------|-----|-------|-----|-------|---|
| IBERITAL | | | | | • | | | | |
| INNOVA | | | | | • | | | | Steel, Dream, Arc, Elipse |
| ISOMAC | | | | | | | • | • | |
| ITALCREM | | | | | • | | • | | |
| KEES VAN DER WESTEN | | | | | | | | • | |
| KRUPS | • | | | | | | | | |
| LA MARZOCCO | | | | | | | • | • | |
| LA PAVONI | • | | | | | | | | Europiccola Pre-Millenium version |
| LA PAVONI | | • | | | | | | | Lusso and Pisa models |
| LA PAVONI | | | | | • | | | | Club Combo, Duet, Napolitana, Domus Bar |
| LA PAVONI | | | | | | | • | • | |
| LA SCALA NORD EST | | | | | | | • | • | |
| LA SPAZIALE | | • | | | | | | | |
| LELIT | | | | | • | | | | Home models |
| LELIT | | | | | • | | • | | |
| MAGISTER | | | | | • | | • | | |
| MAIRALI | | | | | • | | • | | |
| NUOVA SIMONELLI | | | | | | | • | • | |
| OLYMPIA EXPRESS | • | | | | | | | | |
| ORCHESTRALE | | | | | | | • | • | |
| PROMAC | | | | | • | | • | | |
| RANCILIO | | | | | • | | • | | |
| RENEKA | | | | | • | | | | |
| ROCKET | | | | | | | • | • | |
| SAECO HOME | | • | | | | | | | |
| SAN MARCO | | • | • | | | | | | |
| SAN REMO | | | | | • | | • | | |
| SLAYER | | | | | | | | • | |
| SOLIS | | • | | | | | | | |
| STARBUCKS HOME | | • | | | | | | | |
| SV SAB ITALIA | | | | | | | • | • | |
| SYNESSO | | | | | | | • | • | |
| UNIC | | | | | • | | | | |
| VFA | | | | | • | | | | Express |
| VIBIEMME | | | | | • | | • | | |
| VICTORIA ARDUINO | | | | | • | | • | • | |
| VISACREM | | | | | • | | • | | |
| WEGA | | • | | | | | | | Concept |
| WEGA | | | | | | | • | • | |
| XLVI | | | | | | | • | • | |

KNOCK BOXES



LF Code: 1480008
GEV Code: LF1480008

KNOCKBOX OF STAINLESS STEEL BARISTAPRO

dimensions 300x200x56 mm
dimensions with handle 345x200x56 mm
handle for easy grip
upper vents for steam discharge
triangular bar for noise dampening
reinforced bar support
feet designed to ensure solidity and noise reduction
polished stainless steel



LF Code: 5092769
GEV Code: LF5092769

KNOCKBOX OF STAINLESS STEEL BARISTAPRO

dimensions 370x280x100 mm
dimensions with handle 425x280x100 mm
handle for easy grip
upper vents for steam outlet
triangular bar to silence the noise
reinforced stick support
feet designed to give solidity and noise reduction
polished stainless steel



LF Code: 1480020
GEV Code: LF1480020

KNOCKBOX OF STAINLESS STEEL BARISTAPRO

dimensions 370x280x85 mm
upper vents for steam outlet
triangular bar to silence the noise
feet studied to ensure solidity and noise reduction
polished stainless steel



LF Code: 5092766
GEV Code: LF5092766

KNOCKBOX OF STAINLESS STEEL BARISTAPRO

dimensions 370x265x85 mm
upper vents for steam outlet
triangular bar to silence the noise
feet studied to ensure solidity and noise reduction
flush handle - brushed satinized stainless steel



LF Code: 5092768
GEV Code: LF5092768

KNOCKBOX OF STAINLESS STEEL BARISTAPRO

Dimensions 225x165x95 mm
Triangular bar to silence the noise
Mirror polish



LF Code: 1480600
GEV Code: LF1480600

TRUKJ BAG HOLDER FOR KNOCKBOXES

Bag holder for knockbox suitable for any drawer as it can be adjusted to the size of the box.
Adjustable length from 90 to 180 mm.
Adjustable width from 270 to 460 mm.
Suitable for drawers and hoppers.
Stainless steel structure.
Simplifies cleaning and waste disposal.
Easily detachable.
Stops:
Visibly stained drawer
Box removal for emptying
Removal of spent coffee grounds



LF Code: 1480601
GEV Code: LF1480601

TRUKJ HOSE COVER OF POLYURETHANE

Made of high-strength polyurethane with non-deformable memory foam.
Can be stacked on top of existing knockbox tubes with \varnothing 30/40 mm.
Adjustable in length with incisions for cutting to size from 310 to 180 mm.
Trukj tube cover consists of 2 sections:
- One smooth for beating coffee grounds and
- One with flaps for cleaning coffee residues on the edge of the filter holder unit.
Prevents: Deformed and dirty knockbox tubes, Cleaning coffee filter edge with a sponge, Annoying noises
Dishwasher-safe



LF Code: 1480300
GEV Code: LF1480300

DRAWER THE KNOCKBOX

brand RIBELLE
BPA free
Dishwasher safe
Recyclable
Black colour
Base \varnothing 140 mm
Opening \varnothing 160 mm
Front height 100 mm
Rear height 170 mm



LF Code: 1480021
GEV Code: LF1480021

KNOCKBOX OF PLASTIC BLACK

\varnothing at base 100 mm
upper \varnothing 113 mm, height 106 mm
not dishwasher safe



LF Code: 1480016
GEV Code: LF1480016

KNOCKBOX OF PLASTIC GREY

\varnothing at base 100 mm
upper \varnothing 113 mm, height 106 mm
not dishwasher safe



LF Code: 1480017
GEV Code: LF1480017

KNOCKBOX OF PLASTIC RED

\varnothing at base 100 mm
upper \varnothing 113 mm, height 106 mm
not dishwasher safe

THE KNOCKBOX

The unconventional and bar free knock-box for professional and home baristas for quick disposal of espresso grounds.

Perfect for any espresso machine big or small, for shop or home use.

Made of BPA-free good quality plastic, it is quiet to use thanks to a non-slip rubber base. It is also easy to clean and can be placed in dishwashers.

www.ribellelab.coffee



LF Code: 1480300
GEV Code: LF1480300

RIBELLE LAB
COFFEE YOUR OWN WAY

MILK PITCHERS



LF Code: 1224901
GEV Code: 960000

MILK PITCHER 0.40 l

made of stainless steel



LF Code: 1224911
GEV Code: LF1224911

MILK PITCHER 0.40 l BLACK PTFE COATED

made of stainless steel with internal measurement scale in ounces and milliliters on both sides



LF Code: 1224902
GEV Code: 960001

MILK PITCHER 0.60 l

made of stainless steel



LF Code: 1224912
GEV Code: LF1224912

MILK PITCHER 0.60 l BLACK PTFE COATED

made of stainless steel with internal measurement scale in ounces and milliliters on both sides



LF Code: 1224903
GEV Code: 960002

MILK PITCHER 1 l

made of stainless steel Aisi 202



LF Code: 1224904
GEV Code: 960003

MILK PITCHER 1.5 l

made of stainless steel Aisi 202



LF Code: 5057732
GEV Code: LF5057732

MILK PITCHER EUROPA BLACK 0.35 l

made of stainless steel 18/10 internal sanded finishing - painted externally



LF Code: 1224060
GEV Code: LF1224060

MILK PITCHER EUROPA BLACK 0.50 l

made of stainless steel 18/10 internal sanded finishing - painted externally



LF Code: 1224061
GEV Code: LF1224061

MILK PITCHER EUROPA BLACK 0.75 l

made of stainless steel 18/10 internal sanded finishing - painted externally



LF Code: 5057755
GEV Code: LF5057755

MILK PITCHER EUROPA WHITE 0.35 l

made of stainless steel 18/10 internal sanded finishing - painted externally



LF Code: 1224050
GEV Code: LF1224050

MILK PITCHER EUROPA WHITE 0.50 l

made of stainless steel 18/10 internal sanded finishing - painted externally



LF Code: 1224051
GEV Code: LF1224051

MILK PITCHER EUROPA WHITE 0.75 l

made of stainless steel 18/10 internal sanded finishing - painted externally



LF Code: 1224100
GEV Code: LF1224100

MILK PITCHER WITH SPOUT 0.35 l COATED

made of stainless steel 18/10 external rubber grip anti burn, non slip



LF Code: 1224102
GEV Code: LF1224102

MILK PITCHER WITH SPOUT 0.60 l COATED

made of stainless steel 18/10 external rubber grip anti-scald and non slip



LF Code: 1224016
GEV Code: 542529

BUILT-IN MILK PITCHER WASHER

external dimensions 175x162x115 mm
hole dimensions 155x140 mm
cold water connection 3/8" John Guest
drain connection 1/2"



LF Code: 1224038
GEV Code: 542255

COUNTER MILK PITCHER WASHER

external dimensions 175x164x115 mm
cold water connection \varnothing 1/2" M
connection for hose outlet \varnothing 16 mm

DIGITAL SCALES



LF Code: 1017027
GEV Code: LF1017027

DIGITAL SCALE MTT 200 g

dimensions 75x110x25 mm -
batteries included
measuring units: g - oz - ct - gn
accuracy: 0.01g
automatic OFF function
CALIBRATION function
LOW BATTERY function
BLACK colour



LF Code: 1017004
GEV Code: LF1017004

DIGITAL SCALE 600 g

dimensions 116x78x20 mm -
batteries included
units of measurement: g - oz -
dwt - gn
precision: 0.1g
automatic OFF function
TARE function
BLACK colour



LF Code: 1017002
GEV Code: LF1017002

DIGITAL SCALE MIX 1000 g

dimensions 125x78x18 mm -
batteries included
unit of measure: g - ozt - ct -
dwt - gn
precision: 0.1g
automatic OFF function
TARE function
LOW BATTERY function



LF Code: 1017026
GEV Code: LF1017026

DIGITAL SCALE 1000 G SHOCKPROOF

dimensions 142x82x25 mm -
batteries included
measuring unit: g - oz - dwt - gn
accuracy: 0.1 g
automatic OFF function
CALIBRATION function
GREEN/BLACK colour



LF Code: 1017029
GEV Code: LF1017029

SCALE CASE HIROIA JIMMY

Take your JIMMY scale
anywhere in style and saving
space.
Dimensions 132x172xH50 mm
Durable, elegant, magnetic
closure.
Space for other accessories.
Not washable, can be cleaned
with a damp cloth.



LF Code: 1017028
GEV Code: LF1017028

DIGITAL SCALE HIROIA JIMMY 2000 g

JIMMY is an innovative design
scale that combines coffee and
high technology.
Perfect for both coffee and pour
over.
Removable magnetic display,
reposition it wherever you want.
Water resistant.
6 different working modes.
Management app available.
Dimensions with display
120x145xH25 mm
Dimensions without display
120x120xH19 mm
Capacity 2000 g - accuracy 0.1 g



LF Code: 1017032
GEV Code: LF1017032

SCALE WEIGHT CALIBRATION HIROIA JIMMY

Maintain the accuracy of your
scales.
Weight 100 g
Material: made of stainless steel
Dimensions 36x36xH10 mm



LF Code: 1017030
GEV Code: LF1017030

FILTER HOLDER SUPPORT HIROIA JIMMY

Do you have a filter holder
difficult to weigh?
The JIMMY filter holder is a
great help.
Adjust the angle to suit your
filter holder.
Material: aluminium.
Dimensions 50x115xH10.5 mm
Suitable for all types of filter
holders
Lightweight and slim.
Non-slip bottom.

DIGITAL SCALES



LF Code: 1017031
GEV Code: LF1017031

SILICONE COVER FOR HARIO JIMMY

Protect your JIMMY scale from scratches.
Weighing and preparing is easy thanks to its non-slip surface.
Material: silicone
Dimensions 118x118x2 mm
Washable and reusable.
Non-slip surface prevents equipment from moving.
Protects surface from scratches and bumps.



LF Code: 1017100
GEV Code: LF1017100

DIGITAL SCALE BREWISTA 2000 g

WATERPROOF - 6 DIFFERENT USAGE MODES
dimensions 105x126x20 mm -
batteries included
measuring unit: g-oz
accuracy: 0.1g
TIMER function
automatic OFF function
automatic TARE function
LOW BATTERY function
USB charge function



LF Code: 1235052
GEV Code: LF1235052

DIGITAL SCALE HARIO 2000 g

dimensions 120x190x28 mm -
including batteries
measuring unit: g
accuracy:
200g/0.2g - 500g/1g - 2000g/3g
TIMER ! function
automatic OFF function
TARE function
LOW BATTERY function

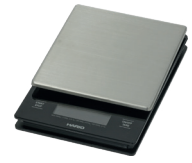

LF Code: 1235114
GEV Code: LF1235114

DIGITAL SCALE HARIO 2000 g

dimensions 120x175x30 mm -
rechargeable batteries
unit of measurement: g
precision:
200g/0.2g - 500g/1g - 200g/3g
TIMER ! function
automatic off function
TARE function
LOW BATTERY function
STAINLESS STEEL plate
rechargeable batteries through
included USB cable



LF Code: 1017500
GEV Code: LF1017500

DIGITAL SCALE 3000 g

dimensions 130x190x28 mm
scale and timer: simultaneous
measurement both the weight
and extraction time
silicone mat to protect the scale
base
Touch All-in-One button
green backlit screen
automatic shutdown in 5
minutes
(not active if the timer is
running)
usable with 2 batteries 1.5V AAA
units of measurement: g/ml -
oz - Lb
precision 0.1 g



BREW GROUP SHOWER SCREENS



LF Code: 1081118
GEV Code: LF1081118

PRECISION SHOWER SCREEN NANOTEC ø 48 mm

non-stick NANOQUARTZ coating increases the resistance to corrosion and to chemical reaction
middle hole 5 mm
63 holes ø 3 mm
Aisi 316 steel - food-safe certified
integrated membrane 200 µm
suitable for machines
DASTORIA/CMA-SAN MARCO-
WEGA



LF Code: 1081119
GEV Code: LF1081119

PRECISION SHOWER SCREEN NANOTEC ø 48.4mm

non-stick NANOQUARTZ coating increases the resistance to corrosion and to chemical reaction
middle hole 5 mm
63 holes ø 3 mm
Aisi 316 steel - food-safe certified
integrated membrane 200 µm
suitable for machines DALLA
CORTE-SPAZIALE

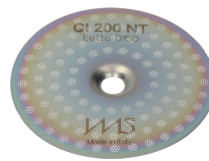

LF Code: 1081600
GEV Code: LF1081600

PRECISION SHOWER SCREEN NANOTEC ø 51.5mm

non-stick NANOQUARTZ coating increases the resistance to corrosion and to chemical reaction
middle hole 5 mm
98 holes ø 3 mm
Aisi 301 steel - food-safe certified
integrated membrane 200 µm
suitable for machines ASTORIA/
CMA-BEZZERA-BFC
BRASILIA-CARIMALI-CASADIO-
CIMBALI-ELEKTRA-FAEMA
FIORENZATO CS-FRACINO-
gIMAC-RENEKA-ROYAL
SAB ITALIA-SANREMO-SCALA-
VICTORIA ARDUINO-WEGA

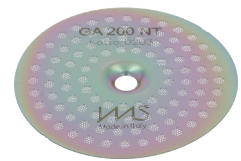

LF Code: 1081120
GEV Code: LF1081120

PRECISION SHOWER SCREEN NANOTEC ø 55 mm

non-stick NANOQUARTZ coating increases the resistance to corrosion and to chemical reaction
middle hole 5 mm
98 holes ø 3 mm
Aisi 316 steel - food-safe certified
integrated membrane 200 µm
suitable for machines GAGGIA-
SAECO

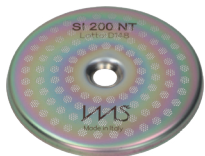

LF Code: 1081603
GEV Code: LF1081603

PRECISION SHOWER SCREEN NANOTEC ø 56.5mm

non-stick NANOQUARTZ coating increases the resistance to corrosion and to chemical reaction
middle hole 6 mm
98 holes ø 3 mm
Aisi 316 steel - food-safe certified
integrated membrane 200 µm
suitable for machines
BRUGNETTI AURORA
NUOVA SIMONELLI-VICTORIA
ARDUINO



LF Code: 1081604
GEV Code: LF1081604

PRECISION SHOWER SCREEN NANOTEC ø 56.5mm

non-stick NANOQUARTZ coating increases the resistance to corrosion and to chemical reaction
middle hole 7 mm
98 holes ø 3 mm
Aisi 316 steel - food-safe certified
integrated membrane 200 µm
suitable for machines
MARZOCCO-SLAYER-SYNESSO



LF Code: 1081602
GEV Code: LF1081602

PRECISION SHOWER SCREEN NANOTEC ø 57 mm

non-stick NANOQUARTZ coating increases the resistance to corrosion and to chemical reaction
middle hole 5.5 mm - 98 holes ø 3 mm
Aisi 316 steel - food-safe certified
integrated membrane 200 µm
suitable for machines BEZZERA-
MAGISTER-PAVONI
PROMAC-RANCILIO

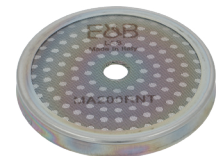

LF Code: 1081122
GEV Code: LF1081122

PRECISION SHOWER SCREEN NANOTEC ø 57.5mm

non-stick NANOQUARTZ coating increases the resistance to corrosion and to chemical reaction
middle hole 7 mm - 121 holes ø 2.2 mm
Aisi 304 steel - food-safe certified
photoengraved membrane 200 µm
reinforced model
suitable for machines
CARIMALI-MARZOCCO-SLAYER
SYNESSO
EAN code 0806891050526

BREW GROUP SHOWER SCREENS

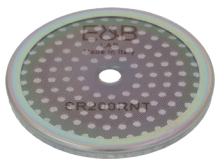

LF Code: 1081126
GEV Code: LF1081126

PRECISION SHOWER SCREEN NANOTEC ø 57.5mm

non-stick NANOQUARTZ coating increases the resistance to corrosion and to chemical reaction
middle hole 6 mm
121 holes ø 2.2 mm
Aisi 304 steel - food-safe certified photoengraved membrane 200 µm reinforced model suitable for machines NUOVA SIMONELLI - RANCILIO
EAN code 0806891050519



LF Code: 1081123
GEV Code: LF1081123

PRECISION SHOWER SCREEN NANOTEC ø 60 mm

non-stick NANOQUARTZ coating increases the resistance to corrosion and to chemical reaction
127 holes ø 2.4 mm
Aisi 304 steel - food-safe certified photoengraved membrane 200 µm reinforced model for GROUPS E61 suitable for machines AZKOYEN-BEZZERA-BFC BIANCHI-BRASILIA-CASADIO-ECM-ECM MANUFACTURE EXPOBAR-FAEMA-FAIMAC-FIAMMA RST-FIORENZATO CS FUTURMAT-GAGGIA SPAGNA-GRIMAC-ITALCREM-MAIRALI ORCHESTRALE-PROMAC-RENEKA-ROYAL-SAB ITALIA SANREMO-SCALA-VFA-VIBIEMME-VICTORIA ARDUINO VISACREM-WEGA
EAN code 0806891050502



LF Code: 1081601
GEV Code: LF1081601

PRECISION SHOWER SCREEN NANOTEC ø 60 mm

non-stick NANOQUARTZ coating increases the resistance to corrosion and to chemical reaction
98 holes ø 3 mm
Aisi 304 steel - food-safe certified integrated membrane 200 µm for E61 GROUPS suitable for machines AZKOYEN-BEZZERA-BFC BIANCHI-BRASILIA-CASADIO-ECM-ECM MANUFACTURE EXPOBAR-FAEMA-FAIMAC-FIAMMA RST-FIORENZATO CS FUTURMAT-GAGGIA SPAGNA-GRIMAC-ITALCREM-MAIRALI ORCHESTRALE-PROMAC-RENEKA-ROYAL-SAB ITALIA SANREMO-SCALA-VFA-VIBIEMME-VICTORIA ARDUINO VISACREM-WEGA



LF Code: 1460212
GEV Code: LF1460212

PRECISION SHOWER SCREEN ø 48 mm

middle hole 5 mm
80 holes ø 2 mm
Aisi 304 steel - food-safe certified wire membrane 35 µm suitable for machines ASTORIA/CMA-SAN MARCO-WEGA



LF Code: 1460210
GEV Code: LF1460210

PRECISION SHOWER SCREEN ø 48 mm

middle hole 5 mm
63 holes ø 3 mm
Aisi 316 steel - food-safe certified integrated membrane 200 µm suitable for machines ASTORIA/CMA-SAN MARCO-WEGA



LF Code: 1460211
GEV Code: LF1460211

PRECISION SHOWER SCREEN ø 48.4 mm

middle hole 5 mm
63 holes ø 3 mm
Aisi 304 steel - food-safe certified integrated membrane 200 µm suitable for machines DALLA CORTE-SPAZIALE

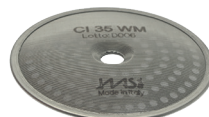

LF Code: 1460205
GEV Code: LF1460205

PRECISION SHOWER SCREEN ø 51.5 mm

middle hole 5 mm
119 holes ø 2 mm
Aisi 304 steel - food-safe certified wire membrane 35 µm suitable for machines ASTORIA/CMA-BEZZERA-BFC BRASILIA-CARIMALI-CASADIO-CIMBALI-ECM-ELEKTRA FAEMA-FIORENZATO CS-FRACINO-GRIMAC-LELIT RENEKA-ROYAL-SAB ITALIA-SANREMO-SCALA VICTORIA ARDUINO-WEGA



LF Code: 1460200
GEV Code: LF1460200

PRECISION SHOWER SCREEN ø 51.5 mm

middle hole 5 mm
98 holes ø 3 mm
Aisi 301 steel - food-safe certified integrated membrane 200 µm suitable for machines ASTORA-BEZZERA-BFC BRASILIA-CARIMALI-CASADIO-CIMBALI-ECM-ELEKTRA FAEMA-FIORENZATO CS-FRACINO-gIMAC-RENEKA ROYAL-SAB ITALIA-SANREMO-SCALA VICTORIA ARDUINO-WEGA

BREW GROUP SHOWER SCREENS



LF Code: 1081140
GEV Code: LF1081140

PRECISION SHOWER SCREEN ø 54 mm

98 holes ø 3.0 mm
Aisi 304 steel - food-safe certified
integrated membrane 200 µm
for Pavoni machines (post-
millennium)



LF Code: 1081099
GEV Code: LF1081099

PRECISION SHOWER SCREEN ø 55 mm

middle hole 5 mm
120 holes ø 2.5 mm
Aisi 316 steel - food-safe certified
wire membrane 35 µm
suitable for machines GAGGIA-
SAECO



LF Code: 1081103
GEV Code: LF1081103

PRECISION SHOWER SCREEN ø 55 mm

middle hole 5 mm
98 holes ø 3 mm
Aisi 316 steel - food-safe certified
integrated membrane 200 µm
suitable for machines GAGGIA-
SAECO



LF Code: 1460204
GEV Code: LF1460204

PRECISION SHOWER SCREEN ø 56.5 mm

middle hole 6 mm
98 holes ø 3 mm
Aisi 316 steel - food-safe certified
integrated membrane 200 µm
suitable for machines
BRUGNETTI AURORA
NUOVA SIMONELLI-VICTORIA
ARDUINO



LF Code: 1460202
GEV Code: LF1460202

PRECISION SHOWER SCREEN ø 56.5 mm

middle hole 7 mm
98 holes ø 3 mm
Aisi 316 steel - food-safe certified
integrated membrane 200 µm
suitable for machines
CARIMALI-MARZOCCO-SLAYER
SYNESSO



LF Code: 1460208
GEV Code: LF1460208

PRECISION SHOWER SCREEN ø 57 mm

middle hole 5,5 mm
112 holes ø 2 mm
Aisi 304 steel - food-safe certified
wire membrane 35 µm
suitable for machines BEZZERA-
MAGISTER-PAVONI
PROMAC-RANCILIO



LF Code: 1460203
GEV Code: LF1460203

PRECISION SHOWER SCREEN ø 57 mm

middle hole 5,5 mm
98 holes ø 3 mm
Aisi 316 steel - food-safe certified
integrated membrane 200 µm
suitable for machines BEZZERA-
MAGISTER-PAVONI
PROMAC-RANCILIO



LF Code: 1460207
GEV Code: LF1460207

PRECISION SHOWER SCREEN ø 57.5 mm

middle hole 7 mm
112 holes ø 2 mm
Aisi 304 steel - food-safe certified
wire membrane 35 µm
suitable for machines
CARIMALI-MARZOCCO-SLAYER
SYNESSO

BREW GROUP SHOWER SCREENS



LF Code: 1460209
GEV Code: LF1460209

PRECISION SHOWER SCREEN ø 57.5 mm

middle hole 6 mm
112 holes ø 2 mm
Aisi 304 steel - food-safe certified
wire membrane 35 µm
suitable for machines
BRUGNETTI AURORA
NUOVA SIMONELLI-VICTORIA
ARDUINO



LF Code: 1460206
GEV Code: LF1460206

PRECISION SHOWER SCREEN ø 60 mm

120 holes ø 2.5 mm
Aisi 304 steel - food-safe certified
wire membrane 35 µm
for GROUPS E61
suitable for machines AZKOYEN-
BEZZERA-BFC
BIANCHI-BRASILIA-CASADIO-
ECM-ECM MANUFACTURE
EXPOBAR-FAEMA-FAIMAC-
FIAMMA RST-FIORENZATO CS
FUTURMAT-GAGGIA SPAGNA-
GRIMAC-ITALCREM-MAIRALI
ORCHESTRALE-PROMAC-
RENEKA-ROYAL-SAB ITALIA
SANREMO-SCALA-VFA-
VIBIEMME-VICTORIA ARDUINO
VISACREM-WEGA



LF Code: 1460201
GEV Code: LF1460201

PRECISION SHOWER SCREEN ø 60 mm

98 holes ø 3 mm
Aisi 304 steel - food-safe certified
integrated membrane 200 µm
for GROUPS E61
suitable for machines AZKOYEN-
BEZZERA-BFC
BIANCHI-BRASILIA-CASADIO-
ECM-ECM MANUFACTURE
EXPOBAR-FAEMA-FAIMAC-
FIAMMA RST-FIORENZATO CS
FUTURMAT-GAGGIA SPAGNA-
GRIMAC-ITALCREM-MAIRALI
ORCHESTRALE-PROMAC-
RENEKA-ROYAL-SAB ITALIA
SANREMO-SCALA-VFA-
VIBIEMME-VICTORIA ARDUINO
VISACREM-WEGA

COFFEE FILTERS



LF Code: 1460018
GEV Code: LF1460018

FILTER BARISTAPRO 2 CUPS 15 g NANOTECH

edge ø 70 mm - height 22 mm - 661 holes

Aisi steel 304 - food-safe certified
Holes made with a precise diameter and number specifically designed and tested to ensure homogeneous extraction and a balanced quantity of soluble in cup. Detached from the filter edge and distributed to the center to eliminate channeling.

Non-stick coating made of NANOQUARTZ increases the resistance to corrosion and chemical reaction

100% made in Italy suitable for machines

ASTORIA CMA, BARISTAPRO, BEZZERA, BFC, BIANCHI, BRASILIA, CASADIO, COFFEE QUEEN, CONTI, CREM, ECM, ECM ESPRESSO COFFEE MACHINES GMBH, ELEKTRA, EXPOBAR, FAEMA, FIORENZATO C.S., FRACINO, FUTURMAT-ARIETE, GAGGIA SPAGNA, GEM-FUTUREMA, GRIMAC, IMS, ITALCREM, MAGISTER, MAIRALI, MARZOCCO, NUOVA SIMONELLI, PAVONI, PROMAC, RANCILIO, ROYAL, SAB ITALIA, SANREMO, SCALA, SYNESSO, VFA EXPRES, VIBIEMME, VICTORIA ARDUINO, VISACREM, WEGA



LF Code: 1460022
GEV Code: LF1460022

FILTER BARISTAPRO 2 CUPS 18 g NANOTECH

edge ø 70 mm - height 24 mm - 661 holes

Aisi steel 304 - food-safe certified
Holes made with a precise diameter and number specifically designed and tested to ensure homogeneous extraction and a balanced quantity of soluble in cup. Detached from the filter edge and distributed to the center to eliminate channeling.

Non-stick coating made of NANOQUARTZ increases the resistance to corrosion and chemical reaction.

100% made in Italy suitable for machines

ASTORIA CMA, BARISTAPRO, BEZZERA, BFC, BIANCHI, BRASILIA, BREVILLE, CASADIO, COFFEE QUEEN, CONTI, CREM, ECM, ECM ESPRESSO COFFEE MACHINES GMBH, ELEKTRA, EXPOBAR, FAEMA, FIORENZATO C.S., FRACINO, FUTURMAT-ARIETE, GAGGIA SPAGNA, GEM-FUTUREMA, GRIMAC, IMS, ITALCREM, MAGISTER, MAIRALI, MARZOCCO, NUOVA SIMONELLI, PAVONI, PROMAC, RANCILIO, ROYAL, SAB ITALIA, SANREMO, SCALA, SYNESSO, VFA EXPRES, VIBIEMME, VICTORIA ARDUINO, VISACREM, WEGA



LF Code: 1460023
GEV Code: LF1460023

FILTER BARISTAPRO 2 CUPS 20 g NANOTECH

edge ø 70 mm - height 26 mm - 661 holes

Aisi steel 304 - food-safe certified
Holes made with a precise diameter and number specifically designed and tested to ensure homogeneous extraction and a balanced quantity of soluble in cup. Detached from the filter edge and distributed to the center to eliminate channeling.

Non-stick coating made of NANOQUARTZ increases the resistance to corrosion and chemical reaction.

100% made in Italy suitable for machines

ASTORIA CMA, BARISTAPRO, BEZZERA, BFC, BIANCHI, BRASILIA, CASADIO, COFFEE QUEEN, CONTI, CREM, ECM, ECM ESPRESSO COFFEE MACHINES GMBH, ELEKTRA, EXPOBAR, FAEMA, FIORENZATO C.S., FRACINO, FUTURMAT-ARIETE, GAGGIA SPAGNA, GEM-FUTUREMA, GRIMAC, IMS, ITALCREM, MAGISTER, MAIRALI, MARZOCCO, NUOVA SIMONELLI, PAVONI, PROMAC, RANCILIO, ROYAL, SAB ITALIA, SANREMO, SCALA, SYNESSO, VFA EXPRES, VIBIEMME, VICTORIA ARDUINO, VISACREM, WEGA



LF Code: 1460024
GEV Code: LF1460024

FILTER BARISTAPRO 2 CUPS 22 g NANOTECH

edge ø 70 mm - height 28 mm - 661 holes

Aisi steel 304 - food-safe certified
Holes made with a precise diameter and number specifically designed and tested to ensure homogeneous extraction and a balanced quantity of soluble in cup. Detached from the filter edge and distributed to the center to eliminate channeling.

Non-stick coating made of NANOQUARTZ increases the resistance to corrosion and chemical reaction.

100% made in Italy suitable for machines

ASTORIA CMA, BARISTAPRO, BEZZERA, BFC, BIANCHI, BRASILIA, BREVILLE, CASADIO, COFFEE QUEEN, CONTI, CREM, ECM, ECM ESPRESSO COFFEE MACHINES GMBH, ELEKTRA, EXPOBAR, FAEMA, FIORENZATO C.S., FRACINO, FUTURMAT-ARIETE, GAGGIA SPAGNA, GEM-FUTUREMA, GRIMAC, IMS, ITALCREM, MAGISTER, MAIRALI, MARZOCCO, NUOVA SIMONELLI, PAVONI, PROMAC, RANCILIO, ROYAL, SAB ITALIA, SANREMO, SCALA, SYNESSO, VFA EXPRES, VIBIEMME, VICTORIA ARDUINO, VISACREM, WEGA

COFFEE FILTERS



LF Code: 1460100
GEV Code: LF1460100

PRECISION FILTER 1 CUP 6/8 g H24.5

edge ø 70 mm - height 24.5 mm - 177 holes
circular holes with conical section
Aisi steel 304 - food-safe certified
matching tamper ø 58 mm
for COFFEE MACHINES
ASTORIA-CASADIO-CONTI-
ELEKTRA-FRACINO-
KEESVANDERWESTEN-
MAGISTER-MARZOCCO
N.SIMONELLI-PAVONI-PROMAC-
RANCILIO-SLAYER-SYNESSO
VICTORIA ARDUINO
for GROUPS E61 ASCASO-
BEZZERA-BFC-BIANCHI
BRASILIA-DID-ECM-EXPOBAR-
FAEMA-FIORENZATO-GRIMAC
IBERITAL-LANUOVAERA-
LASCALA-ORCHESTRALE
QUALITYESPRESSO-ROCKET-
ROYAL-SABITALIA-SANREMO-
VFA-VIBIEMME-WEGA



LF Code: 1460105
GEV Code: LF1460105

PRECISION FILTER 1 CUP 6/9 g H24.5

edge ø 68 mm - height 24.5 mm - 253 holes
circular holes with conical section
Aisi steel 304 - food-safe certified
matching tamper ø 58 mm
for COFFEE MACHINES
CARIMALI-CIMBALI-GAGGIA-
RENEKA



LF Code: 1460110
GEV Code: LF1460110

PRECISION FILTER 1 CUP 6/9 g H25

edge ø 65 mm - height 25 mm - 253 holes
circular holes with conical section
Aisi steel 304 - food-safe certified
matching tamper ø 53 mm
for COFFEE MACHINES
ASTORIAPLUS4YOU-
WEGACONCEPT
SPAZIALE



LF Code: 1460108
GEV Code: LF1460108

PRECISION FILTER 1 CUP 6/9 g H25

edge ø 66 mm - height 25 mm - 293 holes
circular holes with conical section
Aisi steel 304 - food-safe certified
matching tamper ø 53 mm
for COFFEE MACHINES
DALLACORTE-GRUPPOIZZO-
SANMARCO

COFFEE FILTERS



LF Code: 1460101
GEV Code: LF1460101

PRECISION FILTER 1 CUP 7/9 g H26.5

edge ø 70 mm - height 26.5 mm - 253 holes
circular holes with conical section
Aisi steel 304 - food-safe certified
matching tamper ø 58 mm
for GROUPS E61 ASCASO-
BEZZERA-BFC-BIANCHI
BRASILIA-DID-ECM-EXPOBAR-
FAEMA-FIORENZATO-GRIMAC
IBERITAL-LANUOVAERA-
LASCALA-L'ORCHESTRALE
QUALITYESPRESSO-ROCKET-
ROYAL-SABITALIA-SANREMO-
VFA-VIBIEMME-WEGA



LF Code: 1460080
GEV Code: LF1460080

PRECISION FILTER 2 CUPS 12/14 g H20

edge ø 70 mm - height 20 mm - 715 holes
flat bottom
circular holes with tapered section
Aisi steel 304 - food-safe certified
matching tamper ø 58 mm
for KEES VAN DER WESTEN -
Spirit-Speedster models
for type E61 groups
filter without channel (for better
sealing)
purchase of spring 5056010
recommended
EAN code 0806891050373
suitable for machines
ASTORIA CMA, BEZZERA, BFC,
BIANCHI, BRASILIA, CASADIO,
COFFEE QUEEN, CONTI,
CREM, ECM, ECM ESPRESSO
COFFEE MACHINES GMBH,
ELEKTRA, EXPOBAR, FAEMA,
FIORENZATO C.S., FRACINO,
FUTURMAT-ARIETE, GAGGIA
SPAGNA, GRIMAC, GRUPPO
IZZO, IMS, ITALCREM, LA NUOVA
ERA, MAGISTER, MAIRALI,
MARZOCCO, MCE, NUOVA
SIMONELLI, ORCHESTRALE,
PAVONI, PROMAC, RANCILIO,
ROCKET, ROYAL, SAB ITALIA,
SANREMO, SCALA, SYNESSO,
VIBIEMME, VICTORIA ARDUINO,
VISACREM, WEGA



LF Code: 1460081
GEV Code: LF1460081

PRECISION FILTER 2 CUPS 14/16 g H22

edge ø 70 mm - height 22 mm - 715 holes
flat bottom
circular holes with tapered section
Aisi steel 304 - food-safe certified
matching tamper ø 58 mm
for KEES VAN DER WESTEN -
Spirit-Speedster models
per type E61 groups
filter without channel (for better
sealing)
purchase of spring 5056010
recommended
EAN code 0806891050380
suitable for machines
ASTORIA CMA, BEZZERA, BFC,
BIANCHI, BRASILIA, CASADIO,
COFFEE QUEEN, CONTI,
CREM, ECM, ECM ESPRESSO
COFFEE MACHINES GMBH,
ELEKTRA, EXPOBAR, FAEMA,
FIORENZATO C.S., FRACINO,
FUTURMAT-ARIETE, GAGGIA
SPAGNA, GRIMAC, GRUPPO
IZZO, IMS, ITALCREM, LA NUOVA
ERA, MAGISTER, MAIRALI,
MARZOCCO, MCE, NUOVA
SIMONELLI, ORCHESTRALE,
PAVONI, PROMAC, RANCILIO,
ROCKET, ROYAL, SAB ITALIA,
SANREMO, SCALA, SYNESSO,
VIBIEMME, VICTORIA ARDUINO,
VISACREM, WEGA



LF Code: 1460082
GEV Code: LF1460082

PRECISION FILTER 2 CUPS 16/18 g H24

edge ø 70 mm - height 24 mm - 715 holes
flat bottom
circular holes with tapered section
Aisi steel 304 - food-safe certified
matching tamper ø 58 mm
for KEES VAN DER WESTEN -
Spirit-Speedster models
for type E61 groups
filter without channel (for better
sealing)
purchase of spring 5056010
recommended
EAN code 0806891050397
suitable for machines
ASTORIA CMA, BEZZERA, BFC,
BIANCHI, BRASILIA, CASADIO,
COFFEE QUEEN, CONTI,
CREM, ECM, ECM ESPRESSO
COFFEE MACHINES GMBH,
ELEKTRA, EXPOBAR, FAEMA,
FIORENZATO C.S., FRACINO,
FUTURMAT-ARIETE, GAGGIA
SPAGNA, GRIMAC, GRUPPO
IZZO, IMS, ITALCREM, KEES
VAN DER WESTEN, LA NUOVA
ERA, MAGISTER, MAIRALI,
MARZOCCO, MCE, NUOVA
SIMONELLI, ORCHESTRALE,
PAVONI, PROMAC, RANCILIO,
ROCKET, ROYAL, SAB ITALIA,
SANREMO, SCALA, SYNESSO,
VIBIEMME, VICTORIA ARDUINO,
VISACREM, WEGA

COFFEE FILTERS



LF Code: 1460083
GEV Code: LF1460083

PRECISION FILTER 2 CUPS 18/20 g H26

edge ø 70 mm - height 26 mm -
715 holes
flat bottom
circular holes with tapered section
Aisi steel 304 - food-safe certified
matching tamper ø 58 mm
for KEES VAN DER WESTEN -
Spirit-Speedster models
for type E61 groups
filter without channel (for better
sealing)
purchase of spring 5056010
recommended
EAN code 0806891050403
suitable for machines
ASTORIA CMA, BEZZERA, BFC,
BIANCHI, BRASILIA, CASADIO,
COFFEE QUEEN, CONTI,
CREM, ECM, ECM ESPRESSO
COFFEE MACHINES GMBH,
ELEKTRA, EXPOBAR, FAEMA,
FIORENZATO C.S., FRACINO,
FUTURMAT-ARIETE, GAGGIA
SPAGNA, GRIMAC, GRUPPO
IZZO, IMS, ITALCREM, KEES
VAN DER WESTEN, LA NUOVA
ERA, MAGISTER, MAIRALI,
MARZOCCO, MCE, NUOVA
SIMONELLI, ORCHESTRALE,
PAVONI, PROMAC, RANCILIO,
ROCKET, ROYAL, SAB ITALIA,
SANREMO, SCALA, SYNESSO,
VIBIEMME, VICTORIA ARDUINO,
VISACREM, WEGA



LF Code: 1460084
GEV Code: LF1460084

PRECISION FILTER 2 CUPS 20/22 g H28

edge ø 70 mm - height 28 mm -
715 holes
flat bottom
circular holes with tapered section
Aisi steel 304 - food-safe certified
matching tamper ø 58 mm
for KEES VAN DER WESTEN -
Spirit-Speedster models
for type E61 groups
filter without channel (for better
sealing)
purchase of spring 5056010
recommended
EAN code 0806891050410
suitable for machines
ASTORIA CMA, BEZZERA, BFC,
BIANCHI, BRASILIA, CASADIO,
COFFEE QUEEN, CONTI,
CREM, ECM, ECM ESPRESSO
COFFEE MACHINES GMBH,
ELEKTRA, EXPOBAR, FAEMA,
FIORENZATO C.S., FRACINO,
FUTURMAT-ARIETE, GAGGIA
SPAGNA, GRIMAC, GRUPPO
IZZO, IMS, ITALCREM, KEES
VAN DER WESTEN, LA NUOVA
ERA, MAGISTER, MAIRALI,
MARZOCCO, MCE, NUOVA
SIMONELLI, ORCHESTRALE,
PAVONI, PROMAC, RANCILIO,
ROCKET, ROYAL, SAB ITALIA,
SANREMO, SCALA, SYNESSO,
VIBIEMME, VICTORIA ARDUINO,
VISACREM, WEGA

FILTER HOLDER GASKETS



LF Code: 1786430
GEV Code: LF1786430

FILTER HOLDER GASKET Ø 64x52.5x5.5 mm

with external cuts, made with soft, heat-resistant silicone, for easier installation on the group. Higher durability and better sealing.
100% made in Italy
for SAN MARCO



LF Code: 1486055
GEV Code: LF1486055

FILTER HOLDER GASKET Ø 64x52x6.4 mm

with internal cuts, made with soft, heat-resistant silicone, for easier installation on the group. Higher durability and better sealing.
Suitable for machines LA SPAZIALE



LF Code: 1486049
GEV Code: LF1486049

FILTER HOLDER GASKET Ø 71x56x9 mm

conical, made with soft, heat-resistant silicone, for easier installation on the group. higher durability and better sealing..
suitable for machines NUOVA SIMONELLI APPIA
suitable for machines VICTORIA ARDUINO
suitable for machines CIMBALI



LF Code: 1486042
GEV Code: LF1486042

FILTER HOLDER GASKET Ø 72x55x6.1/8 mm

conical - with external cuts produced with heat-resistant silicone, soft consistency for an easier installation on the group. longer durability and better sealing.
suitable for machines MARZOCCO
suitable for machines SLAYER
suitable for machines MAVAM



LF Code: 1486057
GEV Code: LF1486057

FILTER HOLDER GASKET Ø 72x56x8 mm

with internal cuts produced with heat resistant silicone, of soft consistency for an easier installation on the unit. longer life and better seal.
100% made in Italy
suitable for machines ASTORIA
suitable for machines WEGA



LF Code: 1486056
GEV Code: LF1486056

FILTER HOLDER GASKET Ø 72x57x8.5 mm

made with heat-resistant silicone, soft consistency for easier installation on the group higher sealing power and durability
100% made in Italy
suitable for machines GAGGIA DOMESTICO



LF Code: 1486060
GEV Code: LF1486060

FILTER HOLDER GASKET Ø 72x58x7 mm

with external cuts made with soft, heat-resistant silicone, for easier installation on the group. Higher durability and better sealing.
suitable for machines NUOVA SIMONELLI APPIA



LF Code: 1486050
GEV Code: LF1486050

FILTER HOLDER GASKET Ø 73x57x8 mm

with internal cuts made of heat-resistant silicone, soft texture for an easier installation on the unit. longer life and better seal.
suitable for groups type E61



LF Code: 1486040
GEV Code: LF1486040

FILTER HOLDER GASKET Ø 73x57x8.5 mm

with internal cuts, produced with heat-resistant silicone, soft consistency for an easier installation on the group. longer durability and better sealing.
suitable for groups type E61
suitable for machines BEZZERA
suitable for machines BIANCHI
suitable for machines EXPOBAR
suitable for machines FAEMA
suitable for machines SANREMO
suitable for machines SYNESSO
suitable for machines VIBIEMME

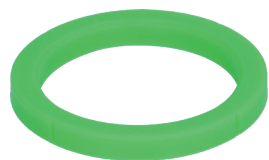

LF Code: 1486054
GEV Code: LF1486054

FILTER HOLDER GASKET Ø 74x57.5x8.5 mm

with internal cuts made with soft, heat-resistant silicone for easier installation on the group. higher durability and better sealing.
suitable for machines RANCILIO



LF Code: 1486065
GEV Code: LF1486065

FILTER HOLDER GASKET Ø 72x58x7.5 mm

with internal cuts produced with heat-resistant silicone, with soft consistency for easier installation on the unit. longer life and better sealing.
Suitable for machines NUOVA SIMONELLI APPIA LIFE.

KRUVE SIFTERS



LF Code: 1235197
GEV Code: LF1235197

KRUVE SIFTER PLUS GRIND SILVER

Kruve Sifter is a professional sifter consisting of aluminium body, wooden lid and 15 sifters for ground coffee: 200, 300, 400, 500, 600, 700, 800, 900, 1000, 1100, 1200, 1300, 1400, 1500, 1600 µm and a sifter holder. Includes a metric ruler up to 16 cm and a table to display the size of the beans and the coffee grind. Dimensions 155x147x75mm



LF Code: 1235198
GEV Code: LF1235198

KRUVE SIFTER PLUS GRIND BLACK

Kruve Sifter is a professional sifter consisting of aluminium body, wooden lid and 15 sifters for ground coffee: 200, 300, 400, 500, 600, 700, 800, 900, 1000, 1100, 1200, 1300, 1400, 1500, 1600 µm and a sifter holder. Includes a metric ruler up to 16 cm and a table to display the size of the beans and the coffee grind. Dimensions 155x147x75mm



LF Code: 1235199
GEV Code: LF1235199

KRUVE SIFTER PLUS BEAN SILVER

Kruve Sifter is a professional sifter consisting of aluminium body, wooden lid, 5 sifters for ground coffee: 300, 500, 800, 1100, 1400 µm, 10 coffee bean sifters: 11, 12, 13, 14, 15, 16, 17, 18, 19, 20/64" and 1 sifter holder. Includes a metric ruler up to 16 cm and a table to display the size of the beans and the coffee grind. Dimensions 155x147x75mm

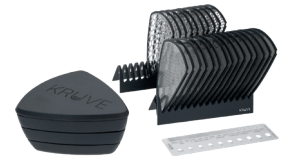

LF Code: 1235201
GEV Code: LF1235201

KRUVE SIFTER MAX BLACK EDITION

Kruve Sifter is a professional sifter consisting of aluminium body, wooden lid, 15 sifters for ground coffee: 200, 300, 400, 500, 600, 700, 800, 900, 1000, 1100, 1200, 1300, 1400, 1500, 1600 µm, 10 coffee bean sifters: 11, 12, 13, 14, 15, 16, 17, 18, 19, 20/64" and 2 sifter holders. Includes a metric ruler up to 16 cm and a table to display the size of the beans and the coffee grind. Dimensions 155x147x75mm



LF Code: 1235202
GEV Code: LF1235202

KRUVE SIFTER MAX SILVER

Kruve Sifter is a professional sifter consisting of aluminium body, wooden lid, 15 sifters for ground coffee: 200, 300, 400, 500, 600, 700, 800, 900, 1000, 1100, 1200, 1300, 1400, 1500, 1600 µm, 10 coffee bean sifters: 11, 12, 13, 14, 15, 16, 17, 18, 19, 20/64" and 2 sifter holders. Includes a metric ruler up to 16 cm and a table to display the size of the beans and the coffee grind. Dimensions 155x147x75mm



LF Code: 1235203
GEV Code: LF1235203

KRUVE SIFTER MAX BLACK

Kruve Sifter is a professional sifter consisting of aluminium body, wooden lid, 15 sifters for ground coffee: 200, 300, 400, 500, 600, 700, 800, 900, 1000, 1100, 1200, 1300, 1400, 1500, 1600 µm, 10 coffee bean sifters: 11, 12, 13, 14, 15, 16, 17, 18, 19, 20/64" and 2 sifter holders. Includes a metric ruler up to 16 cm and a table to display the size of the beans and the coffee grind. Dimensions 155x147x75mm

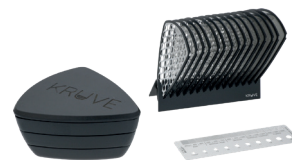

LF Code: 1235204
GEV Code: LF1235204

KRUVE SIFTER PLUS BEAN BLACK EDITION

Kruve Sifter is a professional sifter consisting of aluminium body, wooden lid, 5 sifters for ground coffee: 300, 500, 800, 1100, 1400 µm, 10 coffee bean sifters: 11, 12, 13, 14, 15, 16, 17, 18, 19, 20/64" and 1 sifter holder. Includes a metric ruler up to 16 cm and a table to display the size of the beans and the coffee grind. Dimensions 155x147x75mm



LF Code: 1235205
GEV Code: LF1235205

KRUVE SIFTER PLUS BEAN BLACK

Kruve Sifter is a professional sifter consisting of aluminium body, wooden lid, 5 sifters for ground coffee: 300, 500, 800, 1100, 1400 µm, 10 coffee bean sifters: 11, 12, 13, 14, 15, 16, 17, 18, 19, 20/64" and 1 sifter holder. Includes a metric ruler up to 16 cm and a table to display the size of the beans and the coffee grind. Dimensions 155x147x75mm

KRUBE SIFTERS



LF Code: 1235206
GEV Code: LF1235206

KRUVE SIFTER PLUS GRIND BLACK EDITION

Kruve Sifter is a professional sifter consisting of aluminium body, wooden lid and 15 sifters for ground coffee: 200, 300, 400, 500, 600, 700, 800, 900, 1000, 1100, 1200, 1300, 1400, 1500, 1600 µm and a sifter holder. Includes a metric ruler up to 16 cm and a table to display the size of the beans and the coffee grind. Dimensions 155x147x75mm



LF Code: 1235207
GEV Code: LF1235207

KRUVE SIFTER BASE BLACK EDITION

The Kruve Sifter is a professional sifter consisting of an aluminium body, wooden lid and 5 sifters of 300, 500, 800, 1100 and 1400µm. It includes a metric ruler up to 16 cm and a table to display the size of the beans and the coffee grind. Dimensions 155x147x75mm



LF Code: 1235208
GEV Code: LF1235208

KRUVE SIFTER BASE SILVER

The Kruve Sifter is a professional sifter consisting of an aluminium body, wooden lid and 5 sifters of 300, 500, 800, 1100 and 1400µm. It includes a metric ruler up to 16 cm and a table to display the size of the beans and the coffee grind. Dimensions 155x147x75mm



LF Code: 1881007
GEV Code: LF1881007

KRUVE SIFTER BASE BLACK

The Kruve Sifter is a professional sifter consisting of an aluminium body, wooden lid and 5 sifters of 300, 500, 800, 1100 and 1400µm. It includes a metric ruler up to 16 cm and a table to display the size of the beans and the coffee grind. Dimensions 155x147x75mm



LF Code: 1880038
GEV Code: LF1880038

PAIR OF GLASSES KRUBE EXITE - EXITE

150 ml
Hand-blown borosilicate glass
Double-walled glass that keeps the coffee warm inside and the glass cool to the touch. Its bulb shape preserves the aroma, decreasing acidity and increasing sweetness. Suitable for dark, full-bodied, chocolate or hazelnut roasts. Dishwasher safe
Height 155 mm - Width 98 mm



LF Code: 1880039
GEV Code: LF1880039

PAIR OF GLASSES KRUBE EXITE - INSPIRE

1 Kruve EXITE glass 150 ml suitable for dark, full-bodied, chocolate or hazelnut roasts. 1 Kruve INSPIRE glass 150 ml suitable for light, fruity and citrus roasts. Height 155 mm - Width 98 mm
Hand-blown borosilicate glass
Double-walled glass keeps the coffee warm inside and the glass cool to the touch. Dishwasher-safe



LF Code: 1880040
GEV Code: LF1880040

PAIR OF GLASSES KRUBE INSPIRE - INSPIRE

150 ml
Hand-blown borosilicate glass
Double-walled glass that keeps the coffee warm inside and the glass cool to the touch. It has a narrow internal space that reduces exposure to air, enhances aroma and improves acidity. Suitable for light, fruity and citrus roasts. Height 155 mm - Width 98 mm
Dishwasher safe



LF Code: 1124006
GEV Code: LF1124006

JUG KRUBE PIQUE 300 ml

Hand-blown borosilicate glass
Double-walled glass keeps the coffee warm inside and the jug cool to the touch. Precision casting
Dishwasher safe
height 155 mm - width 115 mm



LF Code: 1124007
GEV Code: LF1124007

JUG KRUBE EVOKE 600 ml

Hand-blown borosilicate glass
Double-walled glass keeps the coffee warm inside and the jug cool to the touch. Precision casting
Dishwasher safe
Height 215 mm - Width 146 mm



LF Code: 1881005
GEV Code: LF1881005

SPOON KRUBE SILVER

Multi-purpose stainless steel spoon used to stir coffee grounds during the brewing process. This results in a better tasting coffee. Dishwasher safe
Dimensions 220x5mm



LF Code: 1881006
GEV Code: LF1881006

SPOON KRUBE BLACK

Multi-purpose stainless steel spoon used to stir coffee grounds during the brewing process. This results in a better tasting coffee. Dishwasher safe
Dimensions 220x5mm



LF Code: 1881008
GEV Code: LF1881008

SPOON KRUBE GOLD

Multi-purpose stainless steel spoon used to stir coffee grounds during the brewing process. This results in a better tasting coffee. Dishwasher safe
Dimensions 220x5mm

BRUSHES



LF Code: 1384003
GEV Code: LF1384003

SHOWER CLEANING BRUSH BLACK

with scoop for detergent and pin to clean the steam holes



LF Code: 1384011
GEV Code: LF1384011

SHOWER CLEANING BRUSH RED

with coffee measuring spoon and pin to clean steam outlet holes



LF Code: 1384001
GEV Code: LF1384001

SHOWER CLEANING BRUSH

100% made in Italy



LF Code: 1384014
GEV Code: LF1384014

SHOWER CLEANING BRUSH RED



LF Code: 1384713
GEV Code: LF1384713

CLEANING BRUSH



LF Code: 1384019
GEV Code: LF1384019

CLEANING BRUSH OF BEECHWOOD

medium rigidity pig bristles with leather string for hanging



LF Code: 1384020
GEV Code: LF1384020

CLEANING BRUSH OF BEECHWOOD

soft pig bristles with leather string for hanging



LF Code: 1384022
GEV Code: LF1384022

CLEANING BRUSH OF WOOD

soft pig bristles with leather string for hanging



LF Code: 1384009
GEV Code: LF1384009

CLEANING BRUSH



LF Code: 1384023
GEV Code: LF1384023

CLEANING BRUSH 50 mm



LF Code: 1384005
GEV Code: LF1384005

CLEANING BRUSH F/ GRINDING BURRS



LF Code: 1384710
GEV Code: LF1384710

SHOWER CLEANING BRUSH STEAM

for steam pipe connection for steam cleaning and sanitizing



LF Code: 3384015
GEV Code: LF3384015

ESPAZZOLA BLACK 53 mm

membrane included
for groups with 53 mm showers,
two or three cam filter holders
with external \varnothing of 64 mm or
more

For professional and semi-
professional machines
DALLA CORTE, LA SAN MARCO,
LA SPAZIALE.

NOT SUITABLE for machines:

LA PAVONI (54mm)

ISOMAC (54mm) models

Diamantina, Venus, Maverick

and Giada, SAGE, BREVILLE

GASTROBACK (54mm)



LF Code: 3384017
GEV Code: LF3384017

MEMBRANE KIT FOR ESPAZZOLA-2+3-53

suitable for ESPAZZOLA-2+3-
53B

suitable for the new version
ESPAZZOLA-2+3-58B

(all ESPAZZOLA 58 mm sold
post April 2021)



LF Code: 3384016
GEV Code: LF3384016

ESPAZZOLA BLACK 58 mm

membrane included
for groups with showers of 56-
58 mm, two or three cam filter
holders with external \varnothing of 69
mm or more.

For professional and semi-
professional machines
ASTORIA - BEZZERA - CIMBALI
- FAEMA - ECM - MARZOCCO -
PROFITEC - RANCILIO - ROCKET
- SLAYER - WEGA.

NOT SUITABLE for machines:
ASCASO models Dream, Acr and
Basic

BEZZERA model Hobby (after
2015)

BREVILLE - DECENT ESPRESSO
- GRAEF

ILLY models Francis - VIBIEMME
models Lollo.

LA PAVONI models Domus Bar
and Domus Casa

LELIT models Anna, Anita, Diana
and Grace

COMPLEMENTARY ACCESSORIES



LF Code: 3494015
GEV Code: LF3494015

APRON OREGON NATURAL

Equipped with:
1 large breast pocket
2 large waist pockets
Leather inserts
With fastening at the back of the neck that allows the bib to be adjusted.
Ideal as a work uniform for wineries, bars, wine shops and bistros.
Material: 100% polyester



LF Code: 3494014
GEV Code: LF3494014

APRON OREGON JEANS

Equipped with:
1 large breast pocket
2 large waist pockets
Leather inserts
With fastening at the back of the neck that allows the bib to be adjusted.
Ideal as a work uniform for wineries, bars, wine shops and bistros.
Material: 100% cotton



LF Code: 1494019
GEV Code: LF1494019

APRON BARISTA PESADO 58.5 SIZE L

durable fabric barista apron (cotton)
with st. steel accessories and adjustable
leather straps to fit perfectly
leather patch protects against heat, water, food
it is removable to be washed by hand
lower width 680 mm
upper width 240 mm
height 850 mm
size "L"



LF Code: 1494018
GEV Code: LF1494018

APRON BARISTA PESADO 58.5 SIZE M

durable fabric barista apron (cotton)
with st. steel accessories and adjustable
leather straps to fit perfectly
leather patch protects against heat, water, food
it is removable to be washed by hand
lower width 600 mm
upper width 220 mm
height 80 mm
size "M"



LF Code: 1494017
GEV Code: LF1494017

APRON BARISTA PESADO 58.5 SIZE S

durable fabric barista apron (cotton)
with st. steel accessories and adjustable
leather straps to fit perfectly
leather patch protects against heat, water, food
it is removable to be washed by hand
lower width 550 mm
upper width 220 mm
height 750 mm
size "S"



LF Code: 1494020
GEV Code: LF1494020

APRON BARISTA PESADO 58.5 SIZE XL

durable fabric barista apron (cotton)
with st. steel accessories and adjustable
leather straps to fit perfectly
leather patch protects against heat, water, food
it is removable to be washed by hand
lower width 710 mm
upper width 260 mm
height 900 mm
size "XL"



LF Code: 1394720
GEV Code: LF1394720

STAINLESS STEEL COFFEE SHOVEL 365 ml

overall length 290 mm - handle 90 mm



LF Code: 1069004
GEV Code: LF1069004

BEATER SPOON

made of STAINLESS STEEL -
overall length 275 mm

COMPLEMENTARY ACCESSORIES



LF Code: 1494024
GEV Code: LF1494024

BEATER WDT COFFEE DISPENSER

wooden handle
made of stainless steel pins
It favours the uniform distribution of coffee inside the filter in order to facilitate its flow and uniform extraction. This improves the taste of the espresso coffee in the cup



LF Code: 1494010
GEV Code: LF1494010

COFFEE SAMPLER FOR JUTE BAGS

tube ø 20 mm - total length 540 mm
stainless steel



LF Code: 1394701
GEV Code: LF1394701

LATTE ART PEN OF ALUMINIUM



LF Code: 1394006
GEV Code: LF1394006

LATTE ART PEN OF ST. STEEL W/BUE GRIP



LF Code: 1394007
GEV Code: LF1394007

LATTE ART PEN OF ST. STEEL W/RED GRIP



LF Code: 1394011
GEV Code: LF1394011

LATTE ART PEN OF STAINLESS STEEL

overall length 135 mm - body ø 3.3 mm
knurled handle



LF Code: 1394005
GEV Code: LF1394005

LATTE ART PEN OF STAINLESS STEEL



LF Code: 1094004
GEV Code: LF1094004

COCOA POWDER SPRINKLER

made of STAINLESS STEEL



LF Code: 1094003
GEV Code: 960006

COCOA POWDER SPRINKLER

made of STAINLESS STEEL



LF Code: 1094905
GEV Code: 960038

COCOA POWDER SPRINKLER ø 6.5 cm

with 3 decorative discs: face/heart/star
stainless steel 18/10



LF Code: 3494013
GEV Code: LF3494013

FUNNEL FOR COFFEE GRINDER HEIGHT 22 mm

made of stainless steel
black colour
upper external ø 70 mm
lower external ø 58 mm
magnetic base



LF Code: 3494012
GEV Code: LF3494012

FUNNEL FOR COFFEE GRINDER HEIGHT 22 mm

made of stainless steel
black colour
upper external ø 64 mm
lower external ø 53 mm
magnetic base

COMPLEMENTARY ACCESSORIES



LF Code: 3494010
GEV Code: LF3494010

FUNNEL FOR COFFEE GRINDER HEIGHT 22 mm

made of stainless steel
upper external \varnothing 64 mm
lower external \varnothing 53 mm
magnetic base



LF Code: 3494011
GEV Code: LF3494011

FUNNEL FOR COFFEE GRINDER HEIGHT 22 mm

made of stainless steel
upper external \varnothing 70 mm
lower external \varnothing 58 mm
magnetic base



LF Code: 1494014
GEV Code: LF1494014

FUNNEL FOR COFFEE GRINDER HEIGHT 40 mm

made of stainless steel
upper external \varnothing 69 mm
lower external \varnothing 58/54 mm
suitable for all brands using
filters
with edge external \varnothing 70 mm



LF Code: 1494015
GEV Code: LF1494015

FUNNEL FOR COFFEE GRINDER HEIGHT 60 mm

made of stainless steel
upper external \varnothing 75 mm
lower external \varnothing 58/54 mm
suitable for all brands using
filters
with edge external \varnothing 70 mm



LF Code: 5056299
GEV Code: LF5056299

GLASS JUG SILK SCREEN PRINTED 22/60 ml

silk-screen printing 22/60 ml -
0.75/2.0 oz
base 42.5x42.5 mm - rim 47x47
mm
height 62 mm



LF Code: 1080200
GEV Code: LF1080200

GLASS JUG SILK SCREEN PRINTED 15/60 ml

silk-screen printing 15/60 ml -
0.5/2 oz
base \varnothing 42.5 mm - rim \varnothing 59.5
mm
height 70 mm



LF Code: 1494009
GEV Code: LF1494009

GLASS JUG SILK SCREEN PRINTED 10/70 ml

with handle and 3 spouts
measuring scale 10 to 70 ml -
1/2 to 2 oz
ideal for both left and right-
handed users
base \varnothing 50.5 mm - rim \varnothing 60.5
mm
overall height 62 mm
not dishwasher safe



LF Code: 1385779
GEV Code: LF1385779

MAT FOR TAMPER/FILTER HOLDER

dimensions 170x140x37 mm
with thermometer-holding hole
for milk pitcher
dishwasher safe



LF Code: 1385734
GEV Code: LF1385734

MAT FOR TAMPER/FILTER HOLDER

dimensions 238x160x48 mm



LF Code: 1385775
GEV Code: 698787

MAT FOR TAMPER/FILTER HOLDER

black colour - dimensions
220x170 mm
dishwasher safe



LF Code: 5135436
GEV Code: LF5135436

MAT FOR TAMPER/FILTER HOLDER

black colour - dimensions
200x150 mm



LF Code: 1385778
GEV Code: LF1385778

MAT FOR TAMPER/FILTER HOLDER

dimensions 200x150x45 mm

COMPLEMENTARY ACCESSORIES



LF Code: 1494012
GEV Code: LF1494012

MAT FOR TAMPER/FILTER HOLDER

black colour- dimensions
207x148 mm
made of food-grade silicone



LF Code: 3494009
GEV Code: LF3494009

MAT KIT KOR EUREKA MIGNON

dimensions 227x280 mm
made of silicone
suitable for all filter holders on
the market,
helps to press your coffees very
easily,
protects the table and the
working environment,
keeping them clean
easy to clean thanks to
washable material
also in the dishwasher
compatible with every Mignon
model,
personalized with Mignon
engraving on the
surface and on the cleaning
brush

MEASURING TOOLS



LF Code: 5071963
GEV Code: LF5071963

ANALOG THERMOMETER ø 45 mm LOGO MOTTA

temperature scale 0+100°C
tip length 125 mm



LF Code: 1394553
GEV Code: LF1394553

ANALOG THERMOMETER ø 25 mm

temperature scale 0+100°C



LF Code: 1394554
GEV Code: LF1394554

ANALOG THERMOMETER ø 45 mm

temperature scale 0+100°C
point length 125 mm



LF Code: 3394966
GEV Code: LF3394966

DIGITAL THERMOMETER -50+150°C/-58+300°F

battery powered and auto power off
measurement unit selectable in degrees °C/°F
LCD reversible display
resolution 0.1°C - accuracy ±1°C
memory button - ON/OFF button
immersion probe ø 4x125 mm
complete with case



LF Code: 3394200
GEV Code: 802116

DIGITAL THERMOMETER -50+300°C/-58+572°F

battery powered
memory function to retrieve and display
MIN and MAX temperature
memory
measurement unit selectable in degrees °C/°F
standard selectable sampling cycle or
fast - normal 10" - fast 2"
timer with buzzer
programmable up to 99 hours and
59 minutes
temperature display resolution
from 0.1°C to 1°C
probe ø 3.5x100 mm - cable
length 1000 mm
table or wall support
in compliance with HACCP
regulation



LF Code: 3394450
GEV Code: LF3394450

INFRARED THERMOMETER

power supply 9V battery
temperature scale: -50+800°C/-
58+1472°F
tolerance ± 2%
laser ray recording <1MW
output 675nm
laser of class 2 type
if the laser beam is directed
onto the item to be
measured, it immediately reads
temperature



LF Code: 1394101
GEV Code: LF1394101

THERMOMETER COFFEE SENSOR FOR GROUPS E61

suitable for all machines using
a type E61 dispensing unit
provides the temperature inside
the group
provides the temperature of the
supply water
M6 connection, steel sensor,
plastic body
overall length 61 mm - ø 37 mm
-50/+300°C -58/+572°F
battery included



LF Code: 1505001
GEV Code: LF1505001

SET 4 HOOKS IN BAG

suitable for assembly and disassembly of o-ring seals, gaskets usually located out of easy reach



LF Code: 5500399
GEV Code: LF5500399

BODKIN GASKET REMOVAL

small bodkin suitable for the removal of coffee group gaskets and gaskets in general
wooden handle
overall length 83 mm



LF Code: 1505002
GEV Code: LF1505002

EXTRACTOR FOR FILTER S.STEEL WITH HOLE



LF Code: 1394001
GEV Code: LF1394001

UNIVERSAL WRENCH

for all steam pipes and coffee groups.
extracts filters and filter holder gaskets
wrench 8/11/12/13 mm
bottle opener

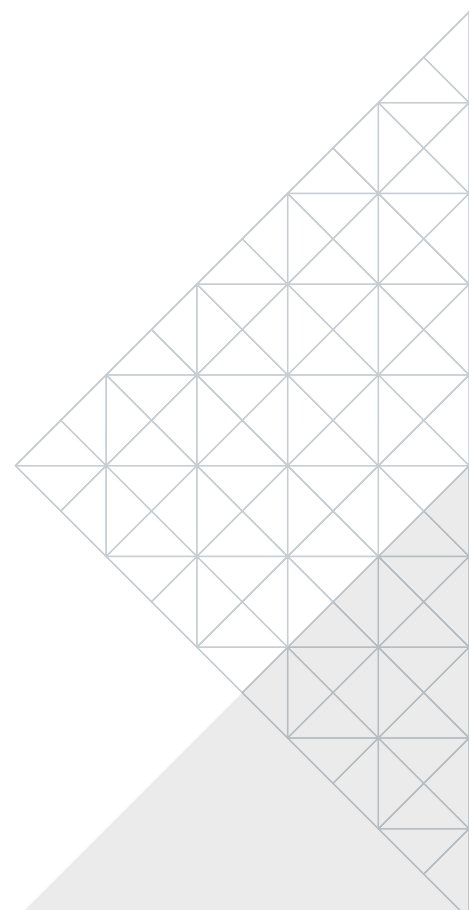

MOKA POTS



LF Code: 1228014
GEV Code: LF1228014

MOKA DELIZIA 3 CUPS GAT BLUE

made in ITALY
safety valve
ergonomic, anti-scald knob and handle
ideal for gas, electric and glass-ceramic stove
aluminium body
silicone gasket
width 88 mm - overall height 165 mm
not dishwasher safe
not suitable for induction



LF Code: 1228017
GEV Code: LF1228017

MOKA DELIZIA 3 CUPS GAT RED

made in ITALY
safety valve
ergonomic, anti-scald knob and handle
ideal for gas, electric and glass-ceramic stove
aluminium body
silicone gasket
width 88 mm - overall height 165 mm
not dishwasher safe
not suitable for induction



LF Code: 1228020
GEV Code: LF1228020

MOKA DELIZIA 3 CUPS GAT YELLOW

made in ITALY
safety valve
ergonomic, anti-scald knob and handle
ideal for gas, electric and glass-ceramic stove
aluminium body
silicone gasket
width 88 mm - overall height 165 mm
not dishwasher safe
not suitable for induction



LF Code: 1228015
GEV Code: LF1228015

MOKA DELIZIA 6 CUPS GAT BLUE

made in ITALY
safety valve
ergonomic, anti-scald knob and handle
ideal for gas, electric and glass-ceramic stove
aluminium body
silicone gasket
width 98 mm - overall height 205 mm
not dishwasher safe
not suitable for induction



LF Code: 1228021
GEV Code: LF1228021

MOKA DELIZIA 6 CUPS GAT YELLOW

made in ITALY
safety valve
ergonomic, anti-scald knob and handle
ideal for gas, electric and glass-ceramic stove
aluminium body
silicone gasket
width 98 mm - overall height 205 mm
not dishwasher safe
not suitable for induction



LF Code: 1228032
GEV Code: LF1228032

MOKA DELIZIA NEW 6 CUPS GAT RED

made in ITALY
safety valve
ergonomic and anti-scalding handle and knob
for gas, electric, glass-ceramics, induction
aluminium body
silicone gasket
width 98 mm - overall height 205 mm
not dishwasher safe



LF Code: 1224027
GEV Code: LF1224027

MOKA EXPRESS 3 CUPS BIALETTI

the Italian excellence of coffee
safety valve
anti-scald handle and knob
suitable for gas-electric-glass ceramic
aluminium body
width 90 mm - overall height 158 mm
not dishwasher safe
not suitable for induction



LF Code: 1228003
GEV Code: LF1228003

MOKA EXPRESS 3 CUPS BLACK BIALETTI

the Italian excellence of coffee
safety valve
Anti-burn handle and knob
suitable for gas-electric-glass ceramic
aluminium body
width 90 mm - overall height 158 mm
not dishwasher safe
not suitable for induction



LF Code: 1228009
GEV Code: LF1228009

MOKA EXPRESS 3 CUPS RED BIALETTI

the Italian excellence of coffee
safety valve
ergonomic and anti-scald handle and knob
suitable for gas-electric-glass ceramic
aluminium body
width 90 mm - total h 158 mm
not dishwasher safe
not suitable for induction



LF Code: 1228001
GEV Code: LF1228001

MOKA EXPRESS 6 CUPS BIALETTI

the Italian excellence of coffee
safety valve
Anti-burn handle and knob suitable for gas-electric-glass ceramic
aluminium body
width 108 mm - overall height 210 mm
not dishwasher safe
not suitable for induction



LF Code: 1228004
GEV Code: LF1228004

MOKA EXPRESS 6 CUPS BLACK BIALETTI

the Italian excellence of coffee
safety valve
Anti-burn handle and knob suitable for gas-electric-glass ceramic
aluminium body
width 108 mm - overall height 210 mm
not dishwasher safe
not suitable for induction



LF Code: 1228005
GEV Code: LF1228005

MOKA EXPRESS 6 CUPS RED BIALETTI

the Italian excellence of coffee
safety valve
Anti-burn handle and knob suitable for gas-electric-glass ceramic
aluminium body
width 108 mm - overall height 210 mm
not dishwasher safe
not suitable for induction



LF Code: 1228023
GEV Code: LF1228023

MOKA LADY 4 CUPS GAT STAINLESS STEEL

made in ITALY
safety valve
ergonomic, anti-scald knob and handle
ideal for gas, electric, glass-ceramic, induction
made of stainless steel body
18/10
width 90 mm - overall height 173 mm
not dishwasher safe



LF Code: 1228024
GEV Code: LF1228024

MOKA LADY 6 CUPS GAT STAINLESS STEEL

made in ITALY
safety valve
ergonomic, anti-scald knob and handle
ideal for gas, electric, glass-ceramic, induction
made of stainless steel body
18/10
width 103 mm - overall height 206 mm
not dishwasher safe



LF Code: 1228006
GEV Code: LF1228006

MOKA VENUS 4 CUPS BIALETTI

the Italian excellence of coffee
safety valve
Anti-burn handle and knob suitable for gas-electric-glass ceramic-induction
made of stainless steel body
18/10
width 98 mm - overall height 172 mm
dishwasher safe



LF Code: 1228007
GEV Code: LF1228007

MOKA VENUS 6 CUPS BIALETTI

the Italian excellence of coffee
safety valve
Anti-burn handle and knob suitable for gas-electric-glass ceramic-induction
made of stainless steel body
18/10
width 107 mm - overall height 200 mm
dishwasher safe

CUPS AND GLASSES



LF Code: 1880036
GEV Code: LF1880036

COFFEE CUP FOR TASTING 200 ml

PORCELAIN - 200 ml (6.76 fl oz)
brown inside
upper ø 98 mm
height 57 mm



LF Code: 1880037
GEV Code: LF1880037

COFFEE CUP FOR TASTING 200 ml

PORCELAIN - 200 ml (6.76 fl oz)
white inside
upper ø 98 mm
height 57 mm



LF Code: 1880034
GEV Code: LF1880034

SET 2 COFFEE CUPS STEEL MOTTA

capacity 80 ml/cc
cup height 50 mm
cup ø 70 mm
material stainless steel 18/10
conical shape
complete with saucers
dishwasher safe



LF Code: 1880035
GEV Code: LF1880035

SET 2 CAPPUCCINO CUPS STEEL MOTTA

capacity 160 ml/cc
cup height 61 mm
cup ø 90 mm
material stainless steel 18/10
conical shape
complete with saucers
dishwasher safe



LF Code: 1880028
GEV Code: LF1880028

SET 6 COFFEE CUPS OF GLASS

capacity 80 ml/cc
cup height 58 mm
cup ø 65 mm
material glass
conical shape
complete with saucers
dishwasher safe



LF Code: 1880029
GEV Code: LF1880029

SET 4 CAPPUCCINO/TEA CUPS OF GLASS

capacity 280 ml/cc
cup height 84 mm
cup ø 95 mm
material glass
conical shape
complete with saucers
dishwasher safe



LF Code: 1880030
GEV Code: LF1880030

SET 6 COFFEE CUPS PORTOFINO

capacity 55 ml/cc
cup height 51 mm
cup ø 62 mm
made of porcelain
conical shape
complete with saucers
dishwasher safe



LF Code: 1880031
GEV Code: LF1880031

SET 6 CAPPUCCINO CUPS PORTOFINO

capacity 190 ml/cc
cup height 70 mm
cup ø 86 mm
made of porcelain
conical shape
complete with saucers
dishwasher safe



LF Code: 1880032
GEV Code: LF1880032

SET 6 COFFEE CUPS TRIESTE

capacity 66 ml/cc
cup height 57 mm
cup ø 64 mm
made of porcelain
conical shape
complete with saucers
dishwasher safe



LF Code: 1880033
GEV Code: LF1880033

SET 6 CAPPUCCINO CUPS TRIESTE

capacity 150 ml/cc
cup height 69 mm
cup ø 90 mm
made of porcelain
conical shape
complete with saucers
dishwasher safe



LF Code: 5150525
GEV Code: LF5150525

SET 4 CUPS BIALETTI ART

capacity 60 ml
cup height 60 mm
cup ø 60 mm
material porcelain
conical shape
complete with coloured saucers
dishwasher safe



LF Code: 5150523
GEV Code: LF5150523

SET 6 CUPS BIALETTI LE COLORATE

capacity 60 ml
cup height 60 mm
cup ø 60 mm
material porcelain
conical shape
complete with coloured saucers
dishwasher safe



LF Code: 5150529
GEV Code: LF5150529

SET 6 CUPS BIALETTI MULTICOLOR

cup height 47 mm
cup ø 28 mm
material porcelain
round shape
complete with cup holder
cup holder height 280 mm
dishwasher safe



LF Code: 5150531
GEV Code: LF5150531

SET 6 CUPS BIALETTI WITH CARTOONS

cup ø 58 mm
material porcelain
round shape
complete with cup holder
cup holder height 280 mm
dishwasher safe

SPOONS FOR COFFEE, CAPPUCCINO, MILK



LF Code: 1881150
GEV Code: LF1881150

PACK 6 COFFEE SPOONS OF STAINLESS STEEL

length 110 mm



LF Code: 1394704
GEV Code: LF1394704

SET 6 COFFEE SPOONS S/ STEEL

length 108 mm



LF Code: 1881003
GEV Code: LF1881003

SPOON ST. STEEL FOR LATTE MACCHIATO

length 205 mm



LF Code: 1881002
GEV Code: LF1881002

SPOON STAINLESS STEEL FOR CAPPUCCINO

length 125 mm



LF Code: 1881004
GEV Code: LF1881004

TASTING SPOON STAINLESS STEEL

length 180 mm

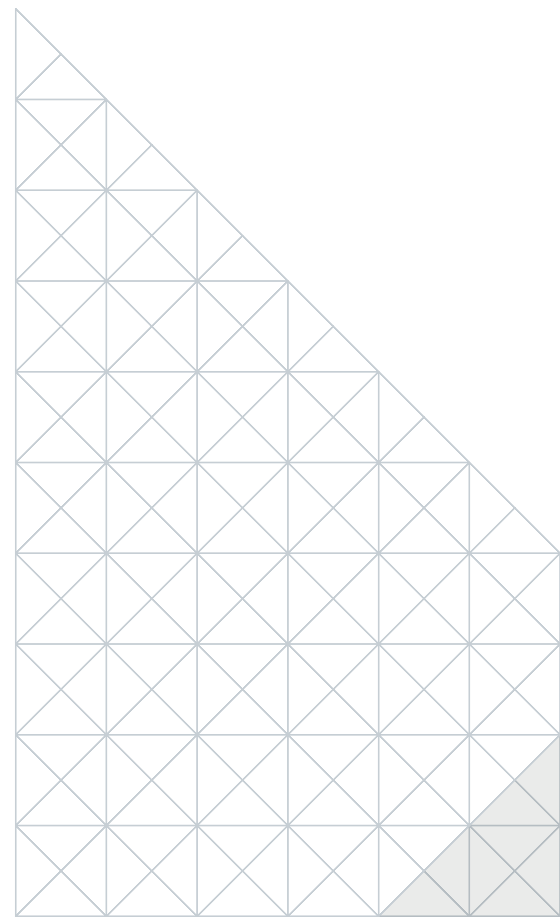

COFFEE MEASURING SPOONS



LF Code: 3069003
GEV Code: LF3069003

DOSER SPOON 15 ml

made of stainless steel with engraved measurements
multi-purpose spoon for coffee, loose tea, sugar, flour or any other food powder
dimensions: 96x42 mm
dishwasher safe



LF Code: 3069002
GEV Code: LF3069002

DOSER SPOON 30 ml

made of stainless steel with engraved measurements
multi-purpose spoon for coffee, loose tea, sugar, flour or any other food powder
dimension: 118x49 mm
dishwasher safe



LF Code: 3069004
GEV Code: LF3069004

DOSER SPOON 5 gr

made of stainless steel
multipurpose spoon for coffee, loose tea, sugar, flour or any other food powder
clip incorporated in the handle to seal the bag and keep the coffee fresh and tasty
extra long handle to reach the bottom of bags and containers
dimensions: 178x37 mm
dishwasher safe



LF Code: 1069002
GEV Code: 802020

DOSER SPOON OF ST. STEEL 20 ml

material made of stainless steel AISI304
overall length 195 mm



LF Code: 1069001
GEV Code: 802103

DOSER SPOON OF PLASTIC 20 ml

overall length 170 mm

EQUIPMENT



LF Code: 1235056
GEV Code: LF1235056

SYSTEM FOR FILTER COFFEE CHEMEX

jug 4-6 cups
dimensions ø 130x220 mm



LF Code: 1235098
GEV Code: LF1235098

SYSTEM FOR FILTER COFFEE CHEMEX

jug 1-3 cups
dimensions ø 110x210 mm



LF Code: 1235129
GEV Code: LF1235129

SYSTEM FOR FILTER COFFEE CHEMEX

jug 6-8 cups
dimensions ø 145x230 mm



LF Code: 1235128
GEV Code: LF1235128

SYSTEM FOR FILTER COFFEE CHEMEX

jug 8-10 cups
dimensions ø 160x235 mm



LF Code: 1235159
GEV Code: LF1235159

COFFEE SYSTEM AEROPRESS GO

To brew excellent coffee with just hot water and a little pressure of your hand.



LF Code: 1235039
GEV Code: LF1235039

COFFEE SYSTEM AEROPRESS

To make excellent coffee using only your hand's pressure and a bit of hot water.



LF Code: 1235041
GEV Code: LF1235041

FILTER FOR AEROPRESS FINE 150 MICRON

made of stainless steel
EAN code 0806891050182

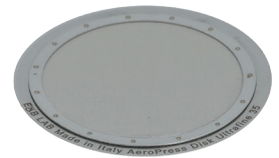

LF Code: 1235068
GEV Code: LF1235068

FILTER FOR AEROPRESS FINE 35 MICRON

made of stainless steel
EAN code 0806891050168

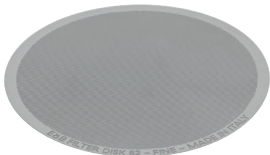

LF Code: 5136755
GEV Code: LF5136755

FILTER FOR AEROPRESS FINE 200 MICRON

made of stainless steel
code EAN 0806891050175



LF Code: 5137093
GEV Code: LF5137093

INJECTION COFFEE SYSTEM DELTER

Injection coffee extraction method with non-return valve



LF Code: 1235061
GEV Code: LF1235061

COFFEE GRINDER HARIO MXR-2

dimensions 108x70x180 mm
conical ceramic burrs
collection drawer capacity approx. 40 g
with anchorage suction cup



LF Code: 1235062
GEV Code: LF1235062

COFFEE GRINDER HARIO CM-502C OF WOOD

dimensions ø 105x200 mm
conical ceramic burrs
collection drawer capacity approx. 40 g



LF Code: 1235063
GEV Code: LF1235063

COFFEE GRINDER HARIO SKERTON MSCS-2DTB

dimensions ø 92x170 mm
conical ceramic burrs
collection glass capacity approx. 100 g



LF Code: 1235064
GEV Code: LF1235064

COFFEE GRINDER MINI HARIO MSS-1DTB

dimensions ø 72x175 mm
conical ceramic burrs
collection glass capacity approx. 14 g



LF Code: 1235090
GEV Code: LF1235090

COFFEE GRINDER HARIO CMHC-4C

dimensions ø 110x190 mm
ceramic conical burrs
collection capacity approx. 120 g



LF Code: 1235101
GEV Code: LF1235101

COFFEE GRINDER HARIO MCW-2

dimensions ø 86x185 mm
conical ceramic burrs
collection drawer capacity approx. 30 g
ceramic and olive wood body

EQUIPMENT



LF Code: 1235191
GEV Code: LF1235191

COFFEE GRINDER HARIO SMART G MSG-2-T

Body dimensions 52x52 mm.
Overall height without lever 150 mm.
Overall height with lever 195 mm.
Ceramic conical grinders.
Grinding adjustment.
Capacity of collecting chamber approx. 24g ref. 2
Capacity of collecting chamber approx. 12g ref. 1
Methacrylate resin body.
Model MSG-2-T



LF Code: 1235192
GEV Code: LF1235192

COFFEE GRINDER HARIO SMART G MSG-2-TB

Body dimensions 52x52 mm
overall height without lever 150 mm
overall height with lever 195 mm
ceramic conical grinders
grinding adjustment
collecting compartment capacity approx. 24g ref. 2
collecting compartment capacity approx. 12g ref. 1
methacrylate resin body
model MSG-2-TB



LF Code: 1480500
GEV Code: 802271

ELECTRIC FILTER CLEANER PRO-FONDI EVO

power supply: in 100/240V 50/60Hz - out 12VCC
complete with 53- and 57-mm rotor
complete with bag-retaining ring
120-mm hole needed for installation
under-counter height 155 mm
NFS certified
eliminates the noise originating from knocking the portafilter clean, enhancing the environment's acoustic comfort
collects and eliminates coffee residue hygienically
takes up less room than a traditional knockbox
for ALL KINDS OF COFFEE MACHINES



LF Code: 5095459
GEV Code: LF5095459

TODDY COLD BREW SYSTEM CMLTCM

container 20 l - 5 gallons
includes 2 standard paper filters
includes 2 green paper filters
complete with:
1 tap, 2 washers and 1 nut
1 lid
1 coffee rise
ø at base 250 mm - cover ø 315 mm
height 395 mm
NSF certificate



LF Code: 1235160
GEV Code: LF1235160

TODDY COLD BREW SYSTEM THM4

cold brew system for coffee and tea
340g coffee tank - 1.65L water tank for coffee cold brew
225g tea leaves tank - 2.3L water tank for tea cold brew
includes 3 paper filter bags
includes 2 felt filters and 1 cap
includes 1 instruction manual
also includes:
1 container, 1 handle
1 decanter, 1 lid
base ø 120 mm - lid ø 175 mm
height 370 mm
BPA-free
made in USA



LF Code: 1235163
GEV Code: LF1235163

COLD BREW SYSTEM BRUER CHARCOAL COL.

charcoal-coloured Bruer cold brew system
this slow drip method is known to produce a less acidic, less bitter cup with exceptional complexity.
produces 0.6L / 20 fl oz in about 4 hours
includes adjustable silicone valve
includes 100 paper filters
includes 1 instruction manual
materials: glass, steel, food grade silicone
ø 120 mm
overall height 245 mm
dishwasher safe



LF Code: 1235164
GEV Code: LF1235164

COLD BREW SYSTEM BRUER GRAY COL.

gray-coloured Bruer cold brew system
this slow drip method is known to produce a less acidic, less bitter cup with exceptional complexity.
produces 0.6L / 20 fl oz in about 4 hours
includes adjustable silicone valve
includes 100 paper filters
includes 1 instruction manual
materials: glass, steel, food grade silicone
ø 120 mm
overall height 245 mm
dishwasher safe



LF Code: 5137092
GEV Code: LF5137092

COLD BREW SYSTEM BRUER BLUE COL.

blue-coloured Bruer cold brew system
this slow drip method is known to produce a less acidic, less bitter cup with exceptional complexity.
produces 0.6L / 20 fl oz in about 4 hours
includes adjustable silicone valve
includes 100 paper filters
includes 1 instruction manual
materials: glass, steel, food grade silicone
ø 120 mm
overall height 245 mm
dishwasher safe

EQUIPMENT



LF Code: 1235115
GEV Code: LF1235115

THERMOMETER -10+100°C E&B LAB

length 200 mm
for coffee system

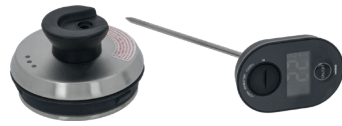

LF Code: 1235123
GEV Code: LF1235123

THERMOMETER HARIO VTM-1B FOR KETTLE

plastic thermometer with steel bulb
complete with adapter cap.
suitable for the models:
EVKB-80EHSV / VKB-120HSV /
VKB-100HSV
detected temperature from
0/110°C.
precision +/- 1°C.
display Celsius degrees.
automatic OFF-function after 45
minutes.
battery LR-44 DC1,5V included.



LF Code: 1235047
GEV Code: LF1235047

SERVING KETTLE HARIO 1.2 L

suitable for: gas - electric -
induction



LF Code: 1235085
GEV Code: LF1235085

SERVING KETTLE HARIO 0.8 L

complete with electric plate
220/240V 50Hz - 900/1000W



LF Code: 1235178
GEV Code: LF1235178

SERVING KETTLE HARIO 1.2 L

suitable for: gas - electric -
induction
ø at base 143 mm
overall height 145 mm
MODEL VKB-120-MB



LF Code: 1235184
GEV Code: LF1235184

SERVING KETTLE HARIO 1.4 L

suitable for: gas - electric -
induction
ø at base 135 mm
overall height 158 mm
MODEL DKG-140-W



LF Code: 1235185
GEV Code: LF1235185

SERVING KETTLE HARIO 1.4 L

suitable for: gas - electric -
induction
ø at base 135 mm
overall height 158 mm
MODEL DKG-140-B



LF Code: 5078829
GEV Code: LF5078829

SERVING KETTLE HARIO 1.0 L

suitable for gas - electric -
induction



LF Code: 1235048
GEV Code: LF1235048

COFFEE DRIPPER OF CERAMIC HARIO 1-2 CUPS

HARIO V60 01
white ceramic filter
for hand infusion
Spiral grooves on the inside
ensure
maximum aroma extraction.



LF Code: 1235049
GEV Code: LF1235049

COFFEE DRIPPER OF CERAMIC HARIO 1-4 CUPS

HARIO V60 02
white ceramic filter
for hand infusion
Spiral grooves on the inside
ensure
maximum aroma extraction.



LF Code: 1235076
GEV Code: LF1235076

COFFEE DRIPPER OF CERAMIC HARIO 1-2 CUPS

HARIO V60 01
colour red
Its opening and spiral grooves
inside ensure maximum aroma
extraction.



LF Code: 1235057
GEV Code: LF1235057

COFFEE DRIPPER OF CERAMIC HARIO 1-4 CUPS

HARIO V60 02
colour red
Its large opening and spiral
grooves
inside ensure maximum aroma
extraction.

EQUIPMENT



LF Code: 1235051
GEV Code: LF1235051

DRIP STAND HARIO

Single Stand Acryl
with integrated drip tray
fits perfectly with the V60 series



LF Code: 1235083
GEV Code: LF1235083

SERVING JUG HARIO 360 ml

HARIO V60 Range Server
Serving jug made of glass and
plastic black
dimensions 130x107x106 mm



LF Code: 1235084
GEV Code: LF1235084

SERVING JUG HARIO 600 ml

Range Server 02
Heat-resistant glass
microwave safe
dishwasher safe
easy to clean



LF Code: 1235112
GEV Code: LF1235112

DRIP STAND E&B LAB

ESPRESSO BREWING LAB by
IMS
width 130 mm - depth 149 mm -
height 180 mm
made of paint iron
designed and made in Italy
EAN code 0806891050199



LF Code: 1235116
GEV Code: LF1235116

DRIP STAND E&B LAB

ESPRESSO BREWING LAB by
IMS
width 130 mm - depth 149 mm -
height 180 mm
stainless steel
designed and made in Italy
EAN code 0806891050205



LF Code: 1235111
GEV Code: LF1235111

SYSTEM FOR FILTER COFFEE E&B LAB

ESPRESSO BREWING LAB by
IMS
jug for 4-6 cups - 560 ml
dimensions \varnothing 90x205 mm
with a flower shaped filter
support V60
with a flower shaped support
for wave filter
made of hand-blown glass
do not expose directly to heat
sources
handwash
designed and made in Italy
EAN code 0806891050120



LF Code: 1235113
GEV Code: LF1235113

SERVING JUG E&B LAB 800 ml

ESPRESSO BREWING LAB by
IMS
jug for 4-6 cups - 800 ml
dimensions \varnothing 130x130 mm
made of hand-blown glass
do not expose directly to heat
sources
handwash
designed and made in Italy
EAN code 0806891050151



LF Code: 5089903
GEV Code: LF5089903

PERCOLATE COFFEE SYSTEM HARIO WDC-6

EQUIPMENT



LF Code: 1235151
GEV Code: LF1235151

SERVING THERMIC JUG 600 ml

ø 120 mm - height 200 mm
polypropylene
dishwasher safe
release button
triple insulation layer
impact resistant
supplied with 4 labels to insert
in the handle:
coffee - tea - decaffeinated - hot
water



LF Code: 1235152
GEV Code: LF1235152

SERVING THERMIC JUG 1200 ml

ø 155 mm - height 250 mm
polypropylene
dishwasher safe
release button
triple insulation layer
impact resistant
supplied with 4 labels to insert
in the handle:
coffee - tea - decaffeinated - hot
water



LF Code: 1235153
GEV Code: LF1235153

COUNTER SERVING THERMOS 4 L

ø 170 mm - height 380 mm
release button
open/close button
swivel base



LF Code: 1235700
GEV Code: LF1235700

COFFEE GRINDER BASE WIDTH 200 mm

Steel base designed for the
cleaning of coffee powder
depositing and dispersing
on the countertop.
Equipped with a grid to collect
non-reusable coffee powder in a
special drawer.
With filter holder and tamper
holder accessories.
Width 200 mm.
Adjustable depth 472, 490, 510
mm.
Useful support for coffee
grinder width 175 mm,
Adjustable length 220, 240, 260
mm
Single extractable knockbox
without guides or retainer.



LF Code: 1235701
GEV Code: LF1235701

COFFEE GRINDER BASE WIDTH 300 mm

Steel base designed for the
cleaning of coffee powder
depositing and dispersing on the
countertop.
Equipped with a grid to collect
non-reusable coffee powder in a
special drawer.
With filter holder and tamper
holder accessories.
Width 300 mm.
Adjustable depth 472, 490, 510
mm.
Useful support for coffee
grinder width 275 mm,
Adjustable length 220, 240, 260
mm
Extractable knockbox without
guides or retainer.
Removable drawer without
guides or retainer.

FILTERS FOR PERCOLATED COFFEE



LF Code: 1235091
GEV Code: LF1235091

CONE FILTERS HARIO 1-2 CUPS 100 PCS

paper made, no side-tastes



LF Code: 1235053
GEV Code: LF1235053

CONE FILTERS HARIO 1-2 CUPS 100 PCS



LF Code: 1235092
GEV Code: LF1235092

CONE FILTERS HARIO 1-4 CUPS 100 PCS

paper made, no side-tastes



LF Code: 1235110
GEV Code: LF1235110

CONE FILTER ULTRA FINE STAIN. S. E&B LAB

ESPRESSO BREWING LAB by IMS
diameter 145 mm
height 96 mm
filtering membrane 35 µm
made of stainless steel 304/316
it replaces the paper filter
specially designed to fit these systems
E&B - HARIO V60 - CHEMEX
designed and made in Italy
EAN code 0806891050106



LF Code: 1235054
GEV Code: LF1235054

CONE FILTERS HARIO 1-4 CUPS 100 PCS

Made in Holland



LF Code: 5088993
GEV Code: LF5088993

CONE FILTERS HARIO 1-4 CUPS 40 PCS

made with oxygen bleached paper
model VCF-02-40W



LF Code: 5129657
GEV Code: LF5129657

FLOWER SUPPORT FOR FILTER V60/CHEMEX

made of stainless steel
EAN code 0806891050144



LF Code: 1235044
GEV Code: LF1235044

PACK OF 100 FILTERS FOR CHEMEX

for 5-6-8-10 cup jug



LF Code: 1235099
GEV Code: LF1235099

PACK OF 100 FILTERS FOR CHEMEX

for 1-3 cup jugs

VACUUM FOOD CONTAINERS



LF Code: 1452002
GEV Code: LF1452002

AIRSCAPE CHROME 850 ml

STAINLESS STEEL
capacity 850 ml / 30 fl oz
external ø 120 mm
height 108 mm
one simple movement removes the air in order to preserve food longer



LF Code: 1452011
GEV Code: LF1452011

AIRSCAPE CHROME 1800 ml

STAINLESS STEEL
capacity 1800 ml / 64 fl oz
external ø 120 mm
height 180 mm
one simple movement removes the air in order to preserve food longer



LF Code: 1452001
GEV Code: LF1452001

AIRSCAPE BLACK 850 ml

STAINLESS STEEL
capacity 850 ml / 30 fl oz
external ø 120 mm
height 108 mm
one simple movement removes the air in order to preserve food longer



LF Code: 1452010
GEV Code: LF1452010

AIRSCAPE BLACK 1800 ml

STAINLESS STEEL
capacity 1800 ml / 64 fl oz
external ø 120 mm
height 180 mm
one simple movement removes the air in order to preserve food longer



LF Code: 1452005
GEV Code: LF1452005

AIRSCAPE MOCHA 850 ml

STAINLESS STEEL
capacity 850 ml / 30 fl oz
external ø 120 mm
height 108 mm
one simple movement removes air in order to preserve food longer



LF Code: 1452013
GEV Code: LF1452013

AIRSCAPE RED 1800 ml

STAINLESS STEEL
capacity 1800 ml / 64 fl oz
external ø 120 mm
height 180 mm
it eliminates air with a simple movement for a longer preservation of food



LF Code: 1452008
GEV Code: LF1452008

AIRSCAPE GLASS 850 ml

capacity 850 ml / 30 fl oz
external ø 125 mm
height 108 mm
BPA-FREE airtight lid
it blows out the air with a simple movement to extend the shelf life of food



LF Code: 1452009
GEV Code: LF1452009

AIRSCAPE GLASS 1800 ml

capacity 1800 ml / 64 fl oz
external ø 125 mm
height 180 mm
BPA-FREE airtight lid
it blows out the air with a simple movement to extend the shelf life of food

COFFEE ADAPTERS



LF Code: 1080271
GEV Code: LF1080271

COFFEE CAN ADAPTER BRASILIA

conical machine connection \varnothing 48.5 mm
f. COFFEE GRINDER BRASILIA/ROSSI



LF Code: 1080272
GEV Code: LF1080272

COFFEE CAN ADAPTER CASADIO

conical machine connection \varnothing 51.5 mm
f. COFFEE GRINDER CASADIO



LF Code: 1080273
GEV Code: LF1080273

COFFEE CAN ADAPTER FAEMA

conical machine connection \varnothing 53 mm
for COFFEE GRINDER FAEMA



LF Code: 5063160
GEV Code: LF5063160

COFFEE CAN ADAPTER MAZZER

conical machine connection \varnothing 58 mm
for COFFEE GRINDER MAZZER



LF Code: 1080274
GEV Code: LF1080274

COFFEE CAN ADAPTER EUREKA

conical machine connection \varnothing 52.5 mm
conical can connection \varnothing 55 mm
for COFFEE GRINDER EUREKA ZENITH 65 SPECIALE



LF Code: 1080261
GEV Code: LF1080261

COFFEE CAN ADAPTER EUREKA

conical machine connection \varnothing 52.5 mm
conical can connection \varnothing 55 mm
f. COFFEE GRINDER EUREKA MDI-CA-OLYMPUS 75/76/77 A



LF Code: 1080268
GEV Code: LF1080268

COFFEE CAN ADAPTER FIORENZATO

conical machine connection \varnothing 67 mm
conical can connection \varnothing 55 mm
for COFFEE GRINDER FIORENZATO DOGE



LF Code: 1080266
GEV Code: LF1080266

COFFEE CAN ADAPTER MACAP

conical machine connection \varnothing 68 mm
conical can connection \varnothing 55 mm
f. COFFEE GRINDER MACAP MXA - M7



LF Code: 1080269
GEV Code: LF1080269

COFFEE CAN ADAPTER MAHLKÖNIG

conical machine connection \varnothing 68 mm
conical can connection \varnothing 55 mm
f. COFFEE GRINDER MAHLKÖNIG K30



LF Code: 1080264
GEV Code: LF1080264

COFFEE CAN ADAPTER MAZZER

conical machine connection \varnothing 63 mm
conical can connection \varnothing 55 mm
f. COFFEE GRINDER MAZZER MAJOR - ROBUR



LF Code: 1080263
GEV Code: LF1080263

COFFEE CAN ADAPTER MAZZER

conical machine connection \varnothing 57.6 mm
conical can connection \varnothing 55 mm
f. COFFEE GRINDER MAZZER SUPER JOLLY



LF Code: 1080262
GEV Code: LF1080262

COFFEE CAN ADAPTER OBEL

conical machine connection \varnothing 64.7 mm
conical can connection \varnothing 55 mm
f. COFFEE GRINDER OBEL MITO - MITO SILENT



LF Code: 1080267
GEV Code: LF1080267

COFFEE CAN ADAPTER QUAMAR

conical machine connection \varnothing 67.5 mm
conical can connection \varnothing 55 mm
for COFFEE GRINDER QUAMAR T80-M80



LF Code: 1080265
GEV Code: LF1080265

COFFEE CAN ADAPTER RANCILIO

conical machine connection \varnothing 67.6 mm
conical can connection \varnothing 55 mm
f. COFFEE GRINDER RANCILIO MD50-ST

DETERGENTS, SPONGES, LIME SCALE REMOVERS, CLOTHS



LF Code: 3092143
GEV Code: 802084

DETERGENT COFFEE CLEAN 900 g

detergent for COFFEE
MACHINES
for the cleaning of filters and
filter holders
for grease and coffee stains on
cups and saucers
please see the attached
documentation for use
code GTIN/EAN 4064145109994



LF Code: 3092543
GEV Code: LF3092543

DETERGENT COFFEE CLEAN 570 g

detergent for COFFEE
MACHINES
for the cleaning of filters and
filter holders
for grease and coffee stains on
cups and saucers
code GTIN/EAN 4064145110013



LF Code: 3092351
GEV Code: LF3092351

DETERGENT COFFEE CLEAN

package with 15 bags 20 g
for coffee groups cleaning



LF Code: 3092350
GEV Code: 802087

DETERGENT COFFEE CLEAN TABLET 2.5 g

60 tablets jar of 2.5 g
for coffee groups cleaning



LF Code: 3092353
GEV Code: 802091

SCALE REMOVER SCALE CLEAN

package with 12 bags 25 g
for the cleaning of BABY coffee
machines
please see the attached
documentation for use



LF Code: 3092352
GEV Code: 802092

SCALE REMOVER SCALE CLEAN 1 kg

acid descaler for aluminium
surfaces, copper, brass, iron



LF Code: 3092355
GEV Code: 802089

DETERGENT CAPPUCCINO PERFECT 1 L

for the cleaning of milk frothers
please see the attached
documentation for use
code GTIN/EAN 4064145110006



LF Code: 3092272
GEV Code: LF3092272

RINSE AID SHINE CLEAN 5 kg

Automatic dosage 0.1%-1%
Rinse aid that helps dish drying
of dishes. Professional use
please see the attached
documentation for use



LF Code: 3092273
GEV Code: LF3092273

RINSE AID SHINE CLEAN 10 kg

Automatic dosage 0.1%-1%
Rinse aid that helps dish drying
of dishes. Professional use
please see the attached
documentation for use



LF Code: 3092270
GEV Code: LF3092270

DETERGENT CLEAR CLEAN 6 kg

Professional use, specific for
dishwashers
glass washers with strong
descaling action
Rinse after use
please see the attached
documentation for use



LF Code: 3092271
GEV Code: LF3092271

DETERGENT CLEAR CLEAN 12 kg

Professional use, specific for
dishwashers
glass washers with strong
descaling action
Rinse after use
please see the attached
documentation for use



LF Code: 3092274
GEV Code: LF3092274

DETERGENT CLEAR CLEAN PLUS 6 kg

Containing Chlorine, specific for
dishwashers, glass washers
Strong rinse aid and descaling
action
Professional use rinse after use
please see the attached
documentation for use

DETERGENTS, SPONGES, LIME SCALE REMOVERS, CLOTHS



LF Code: 3092275
GEV Code: LF3092275

DETERGENT CLEAR CLEAN PLUS 12 kg

Containing Chlorine, specific for dishwashers, glass washers
Strong rinse aid and descaling action
Professional use rinse after use
please see the attached documentation for use



LF Code: 1092213
GEV Code: LF1092213

DETERGENT GRIND CLEANER 340 g

detergent for grinders cleaning natural grain-based ingredients
100% biological
please see the attached documentation for use



LF Code: 1092017
GEV Code: LF1092017

DETERGENT PULY GRIND HOPPER 200 ml

cleans and sanitizes the inside and outside of grinder hoppers without rinsing.
non-flammable, non-hazardous
natural active substances, gentle on the hands,
leaves no residues or odours
Compliant with HACCP regulations



LF Code: 3092076
GEV Code: 802160

DETERGENT PULY GRIND CRYSTALS

for COFFEE GRINDERS and for GRINDER-DOSERS
suitable also for SUPERAUTOMATIC MACHINES
regenerates burrs without disassembling them
does not need to vary the grinding ingredients of natural origin
gluten-free nor allergenic substances
package 10 envelopes
please see the attached documentation for use



LF Code: 3092077
GEV Code: 802158

DETERGENT PULY CAFF PLUS 370 g

detergent for COFFEE MACHINES
suitable for cleaning filters and filter holders
for grease and coffee stains on cups and saucers
please see the attached documentation for use
NSF certified



LF Code: 3092075
GEV Code: 802157

DETERGENT PULY CAFF PLUS 570 g

detergent for COFFEE MACHINES
suitable for cleaning filters and filter holders
for grease and coffee stains on cups and saucers
please see the attached documentation for use
NSF certified



LF Code: 3092074
GEV Code: 950010

DETERGENT PULY CAFF PLUS 900 g

detergent for COFFEE MACHINES
suitable for cleaning filters and filter holders
it removes coffee residues from the brew group
for grease and coffee stains on cups and saucers
please see the attached documentation for use
NSF certified



LF Code: 3092079
GEV Code: 802107

DETERGENT PULY CAFF PLUS

detergent for COFFEE MACHINES
AND SUPERAUTOMATIC MACHINES
suitable for cleaning filters and filter holders
eliminates coffee residues in the brewing unit, drain valve and in all water passages
package of 60 tablets of 2.5 gr ø 16x8 mm
NSF certified
For operating modes, see attached documentation

DETERGENTS, SPONGES, LIME SCALE REMOVERS, CLOTHS



LF Code: 3092078
GEV Code: 802106

DETERGENT PULY CAFF PLUS

detergent for COFFEE MACHINES suitable for cleaning filters and filter holders, eliminates coffee residues in the brewing unit for grease and coffee stains on cups and saucers package of 10 envelopes of 20g NSF certified For operating modes, see attached documentation



LF Code: 3092249
GEV Code: LF3092249

DETERGENT PULY CAFF PLUS

detergent for COFFEE MACHINES AND SUPERAUTOMATIC MACHINES suitable for cleaning filters and filter holders, eliminates coffee residues in the brewing unit, drain valve and in all water passages package of 70 tablets of 0.5 gr ø 10x5 mm NSF certified For operating modes, see attached documentation



LF Code: 3092253
GEV Code: LF3092253

DETERGENT PULY CAFF PLUS

detergent for COFFEE MACHINES AND SUPERAUTOMATIC MACHINES suitable for cleaning filters and filter holders, eliminates coffee residues in the brewing unit, drain valve and in all water passages package of 100 tablets of 1.35 gr ø 16x4 mm NSF certified For operating modes, see attached documentation



LF Code: 3092080
GEV Code: 802159

DETERGENT PULY CAFF PLUS

detergent for COFFEE MACHINES AND SUPERAUTOMATIC MACHINES suitable for cleaning filters and filter holders, eliminates coffee residues in the brewing unit, drain valve and in all water passages package of 100 tablets of 1 gr ø 10x10 mm NSF certified For operating modes, see attached documentation



LF Code: 1092020
GEV Code: LF1092020

DETERGENT PULY CAFF GREEN 1 kg

detergent for COFFEE MACHINES suitable for cleaning filters and filter holders, it removes coffee residues from the brew group for grease and coffee stains on cups and saucers please see the attached documentation for use PHOSPHATE FREE



LF Code: 3092090
GEV Code: LF3092090

DETERGENT PULY CAFF BREW

for FILTER COFFEE, PITCHERS, THERMOS ideal for daily cleaning, removes the coffee residues, eliminates odors. package 120 tabs of 4 g ø 20x8 mm please see the attached documentation for use NSF certified



LF Code: 3092085
GEV Code: 802111

DETERGENT PULY MILK PLUS 1000 ml

ideal for cleaning milk frothers, steam wands and milks pitchers of stainless steel, eliminates the accumulation of milk proteins also in the inner parts please see the attached documentation for use NSF certified



LF Code: 1092032
GEV Code: LF1092032

CLEANING CLOTH BARISTA KIT

includes 4 microfiber cloths: 1 barista cloth 400x600 mm with spring hook 1 generic cleaning cloth 400x400 mm 2 steam wand cleaning cloths 250x250 mm cloth composition: 85% polyester - 15% polyamide machine washable



LF Code: 1092034
GEV Code: LF1092034

BARISTA CLOTH 500x300 mm WITH SNAP-HOOK

microfibre cloth dimension 500x300 mm black colour for cleaning coffee filters and all steel surfaces in the bar CUSTOMISABLE



LF Code: 1092054
GEV Code: LF1092054

BARISTA CLOTH 400x400 mm

dimension 400x400 mm black colour for cleaning coffee filters and all steel surfaces in the bar



LF Code: 1092035
GEV Code: LF1092035

CLEANING CLOTH FOR STEAM PIPES

anti-scald cloth, microfibre external layers silicone internal layer dimensions 150x150 mm

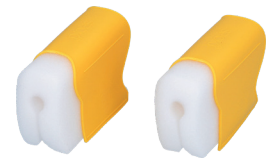

LF Code: 1092600
GEV Code: LF1092600

SPOKJ SPONGE FOR STEAM TUBE KIT 2 PCS

Insulating coating, handy and easy to wash, both by hand and in the dishwasher. Can be squeezed back to its original shape. Can be placed on a flat surface without contact between the sponge and the surface, as it is equipped with protruding fins. Food-safe certification of all components.



GEV Großküchen-Ersatzteil-Vertrieb GmbH

Gadastr. 4
85232 Bergkirchen - Germany
T +49 8142 6522-50
info.ger@repagroup.com
www.gev-online.com

LF S.p.A. a socio unico

Via Voltri 80
47522 Cesena FC - Italy
T +39 0547 341111
info.it@repagroup.com
www.lfspareparts724.com

EPGC S.a.s.

13 Rue des Forts
59960 Neuville en Ferrain - France
T +33 3 20250621
france@repagroup.com
www.epgc.com

Commercial Catering Spares Ltd.

Block C - Axis Point Hill Top Road
Heywood - Lancashire - OL10 2RQ - UK
T +44 1706 621 155
info@ccspares.co.uk
www.ccspares.co.uk

Atel S.r.l. a socio unico

Via Selvuzzis 51/2
33100 Udine UD - Italy
T +39 0432 602095
info@atelitalia.com
www.atelitalia.com

www.repagroup.com

LF1R002

P020322100

